

# Product Catalogue

## MANOCOMB®

Switches, Monitors and (Safety) Limiters  
for Pressure, Vacuum and Differential Pressure

SIL

VdTÜV

PED

DVGW





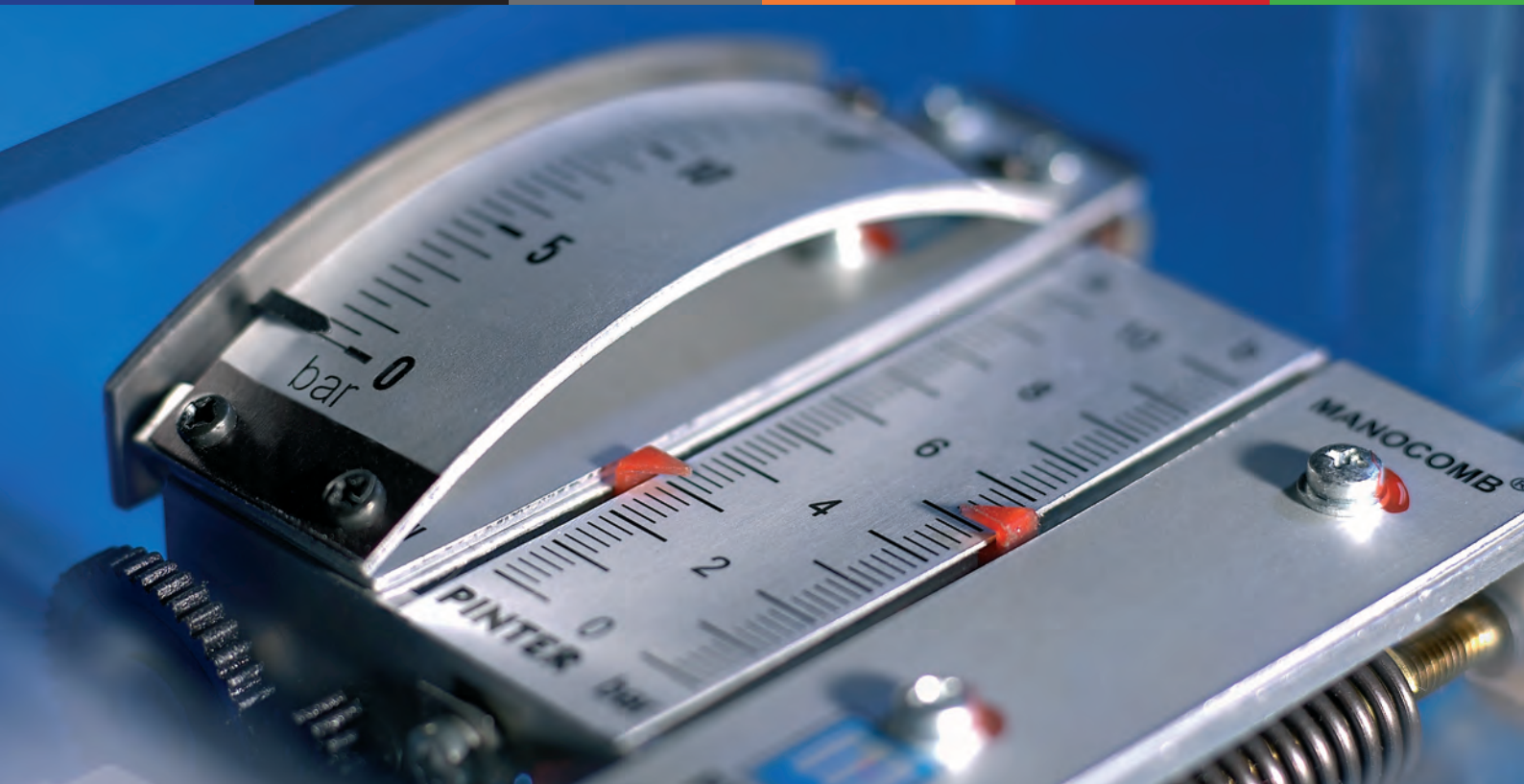



























ATEX

GOST





## CONTENT

<b>INTRODUCTION PRESSURE SWITCHES / PRESSURE MONITORS / SAFETY PRESSURE LIMITERS .....</b>	<b>4</b>
<b>PRODUCTS / PRODUCT MATRIX .....</b>	<b>8</b>
<b>MANOCOMB® model range IP65 (Switch/Monitor/Limiter for Pressure, Diff.-Pressure and Vacuum) .....</b>	<b>10 - 31</b>
     MANOCOMB® Model IP65 .....	10
     MANOCOMB® Model IP65/CV (with internal interlock/manual reset) .....	16
      MANOCOMB® Model IP65/XI (EExi-version) .....	20
      MANOCOMB® Model IP65/XD (EExd-version) .....	24
      MANOCOMB® Model IP65/PN (pneumatic / EExc-version) .....	28
<b>MANOCOMB® model range TM (Switch/Monitor/Limiter for Pressure and Vacuum).....</b>	<b>30 - 35</b>
   MANOCOMB® Model TM (with integr. pressure transmitter) .....	30
<b>MANOCOMB® - other models (Switch for Pressure, Diff.-Pressure and Vacuum) .....</b>	<b>36 - 43</b>
 MANOCOMB® Model IP54 (also with air gap contacts) .....	36
 MANOCOMB® Model 96x96 (for panel mount) .....	40
<b>PINTER • PRODUCTS • PRACTISE.....</b>	<b>44</b>
<b>CONVERSION TABLE FOR PRESSURE UNITS .....</b>	<b>46</b>
<b>INQUIRY CHECKLISTE FOR PRESSURE SWITCHES .....</b>	<b>47</b>

## DEFINITION OF PRESSURE

A force applied uniformly over a certain area is called **pressure**:

$$p = F / A$$

(pressure = force / area)

Pressure (P) besides temperature is one of the most frequently measured physical units. The unit „Pascal“ (Pa) is the SI unit of pressure within the metric unit system. In Europe „bar“ is the most commonly used (SI) unit. It roughly equals with the magnitude of the atmospheric pressure.

$$1 \text{ bar} = 0,1 \text{ MPa} = 0,1 \text{ N/m}^2 = 10^5 \text{ Pa}$$

Particularly in the anglo-american influenced region „psi“ (pounds per square inch) is the most common unit.

The general term „pressure“ is not always very clear:

In technical usage several types of pressure are differentiated, mainly differences between two pressure points, which in general linguistic usage all are called pressure.

To avoid confusion, the various types of pressure are distinguished according to their point of reference:

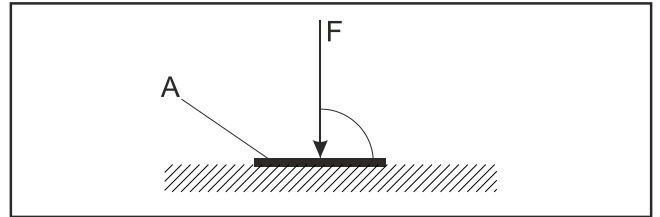
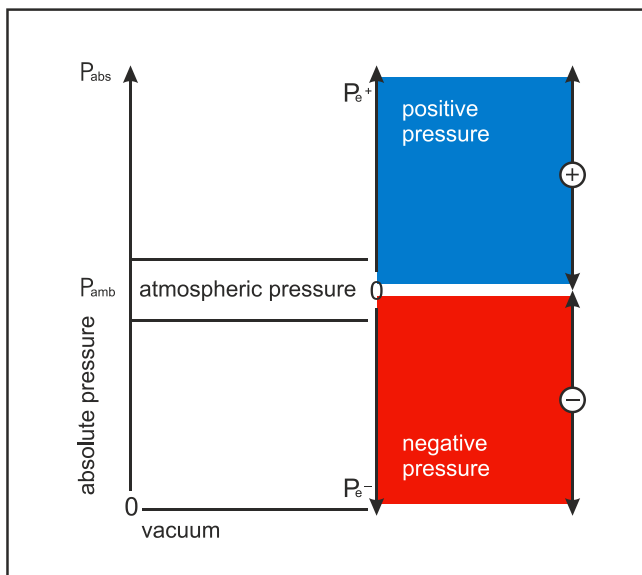

### Absolute Pressure (Pabs)

Absolute pressure always refers to the absolute vacuum, i.e. the zero-point is the absolute vacuum.

*A pressure gauge with measuring range 0 - 10 bar absolute shows the current ambient pressure (Pamb) when in nonoperating state/not installed.*

### Ambient Pressure (Pamb)

The atmospheric pressure is the ambient pressure.

### Atmospheric Pressure Difference (Pe)

The atmospheric pressure difference, also called positive pressure (Pe+) respectively negative pressure (Pe-) is the most commonly measured type of pressure in the technical field.

It refers to atmospheric pressure (Pamb) and is the difference between the atmospheric pressure (Pamb) and absolute pressure (Pabs).

$$P_e = P_{abs} - P_{amb}$$

Pe becomes positive when the absolute pressure is higher than the atmospheric pressure; Pe becomes negative when the absolute pressure is lower than the atmospheric pressure.

*A pressure gauge with measuring range 0 - 10 bar relative shows 0 bar when in nonoperating state/not installed.*

### Differential Pressure (DP)

Differential pressure is the pressure difference ( $\Delta P$ ) between two measured pressures (P1, P2).

$$\Delta P = P_1 - P_2$$

Differential pressure instruments are universal, as they can be used to as a relative pressure instrument or for **hydrostatic level measurement**.

## WHAT IS A PRESSURE SWITCH ?

Pressure switches are signal elements, that can be used for measuring pressure in pressure lines for gases, vapours or liquids.

In general pressure switches have one or more fixed or adjustable switching contacts.

Each switching contact has a **setpoint** (• **SP**). This setpoint corresponds to a pressure value setted on the pressure switch.

When rising above or falling below this value the switching contact within the pressure switch is triggered.

Once the switching contact is triggered, setted pressure values are transformed into electrical or pneumatic signals which are necessary for the

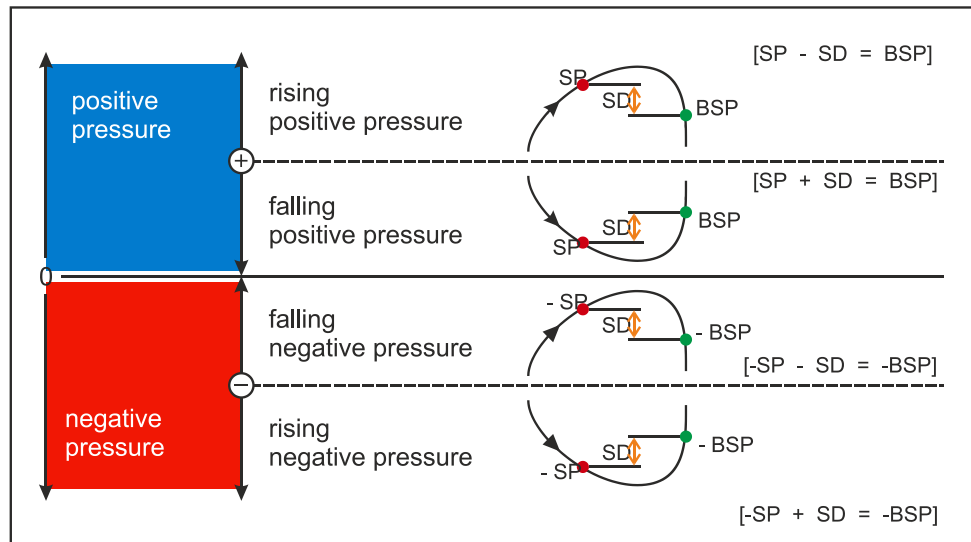

Due to inaccuracy the **re-set point** (• **BSP**) does not exactly match the setpoint. The difference between setpoint and re-setpoint is called hysteresis or **switching differential** (↕ **SD**)

control and regulation of processes, e.g. safety and alarm devices.

## WHAT IS A MANOCOMB® PRESSURE SWITCH ? Not only a pressure switch!

The MANOCOMB® pressure switch is a modular precision pressure instrument based on a force-balance measuring system, that actuates either one or two switching contacts.

rential pressure and vacuum ranges, process connections and electrical / pneumatic connections is available.

These switching contacts can be comfortably adjusted on a calibrated set value input scale (class 1.0). To protect adjusted setpoint from readjusting, a sealable version is available.

Optionally the MANOCOMB® precision pressure switch can be equipped with an integrated pressure gauge (actual value indicator, class 1.0) and/or integrated pressure transducer (analogue signal 4 - 20 mA or 0 - 10 V, 0,5% FS) inside the same housing.

Based on the modular system an enormous number of housing types, switching contact types, pressure, diffe-

This great variety qualifies the MANOCOMB® precision pressure switch for all measuring points and operating conditions.

The MANOCOMB® is also suitable for critical applications, e.g. as safety pressure limiter with internal interlock. Approvals cover SIL, VdTÜV leaflet 100, Pressure Equipment Directive, Gas Appliances Directive and/or ATEX.

Discover more about the different models and options as well as its versatile utilization on the following pages.



## ADVANTAGES OF MANOCOMB® PRECISION PRESSURE SWITCHES

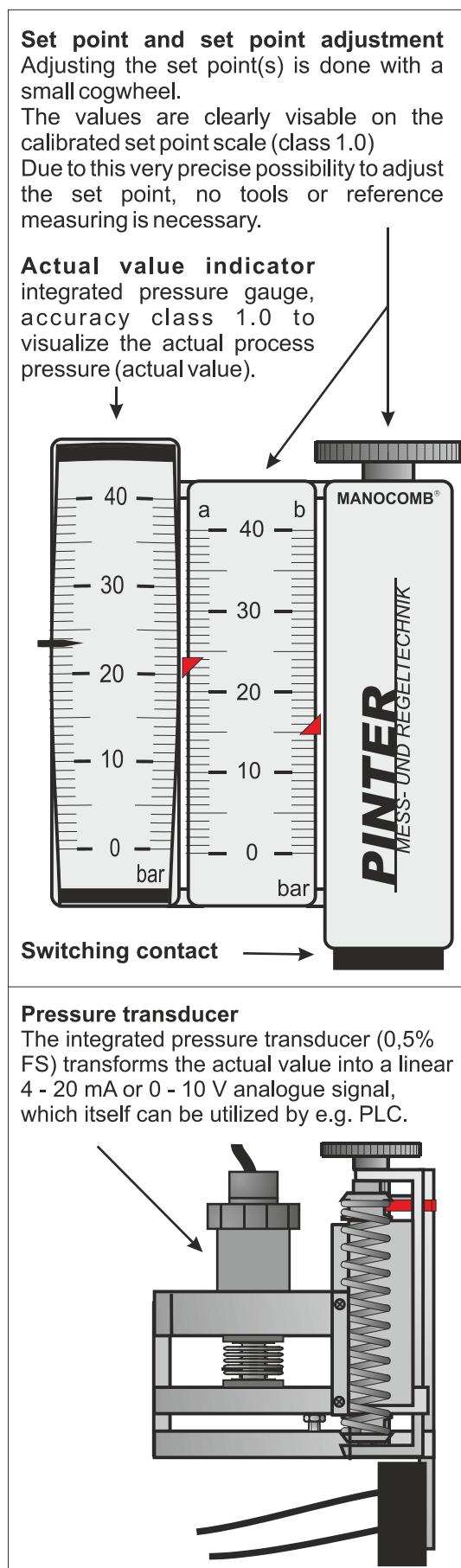

### Differences between MANOCOMB® precision pressure switches and conventional pressure switches:

- high precision and extremely robust force-balance measuring system with bellows and calibrated spring. Without moving axes, turning motions, rotations, hinges or pistons the measuring systems works completely friction free!
- the measuring system is mounted free of tension or torsion in the housing!
- each switch contact has its own measurement system!
- very comfortable switching point adjustment with calibrated reference scale (class 1.0) without tools or reference instruments!
- large selection of switching contacts, for example micro switches, inductive contacts, air cutting contacts, pneumatic valves!
- optionally integrated pressure gauge (class 1.0)!
- optionally integrated pressure transmitter (analogue signal 4 - 20 mA or 0 - 10 V, 0.5% FS)!

### Technical advantages of MANOCOMB® precision pressure switches ?

- The measuring system has no parts subject to wear and tear and is exceptionally precise:  
 hysteresis: depending on contact approx. 0,5 - 3,5%  
 repeatability: depending on contact approx. 0,03%
- virtually unlimited life span!
- insensitive to pressure surges, shock and vibration!
- the adjusted switching point is not affected by body tension!
- High accuracy. Each contact is adjustable independently over the entire measuring range (0 - 100%) and does not interfere with the other!

- For adjusting the switch point no reference instrument is needed. Settings can be comfortably made on-site without affecting safety. Adjusted values can be clearly read from the setpoint scale and compared to the actual pressure value!
- Large selection of switch contacts to optimize the control/switching performance, eg high switching capacity, intrinsically safe circuit, pneumatic output signal!
- Simplified installation arrangements by integrated instruments!

**Economical advantages of MANOCOMB® precision pressure switches ?**

- Lowest losses in uptime due to highly accurate set point adjustment!
- Compact design with small dimensions and simplified installation arrangements by integrating other instruments!
- Proven design without mechanical stress: you do not need any wear parts or spare parts!
- Exact reproducibility and long term stability, which saves you a lot of maintenance hours per year and corrections to the setting!

**Which approvals features the MANOCOMB® precision pressure switch?** (depending on model)

<b>SIL</b>	Safety Integrity Level (IEC 61508/61511) SIL 2 and SIL 3*
<b>VdTÜV</b>	VdTÜV-leaflet Druck 100 Pressure Monitor / Safety Pressure Limiter
<b>PED</b>	Pressure Equipment Directive 97/23/EG Modules B (type examination) and D (QA)
<b>DVGW</b>	Gas Appliances Directive 90/396/EEC, EN1854, DIN DVGW 3398 P3, P4
<b>ATEX</b>	ATEX-Directive 94/9/EC Zones 1 and 2 / Zones 21 and 22
<b>GOST</b>	GOST-R certification proof of conformity with Russian quality standards and regulations

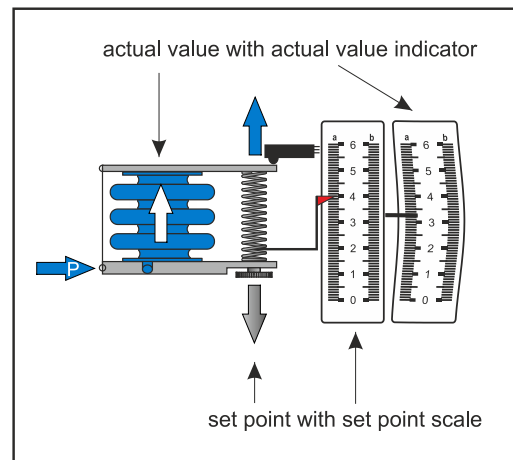

**Force-balance measuring system**

An adjustable tension or stress spring provides the set point.

The process pressure (actual value) acts on the bellows.

Once the actual value opposes the set point adjustment, force-balance-principle, a friction-free mounted lever triggers an electric or pneumatic switching contact.

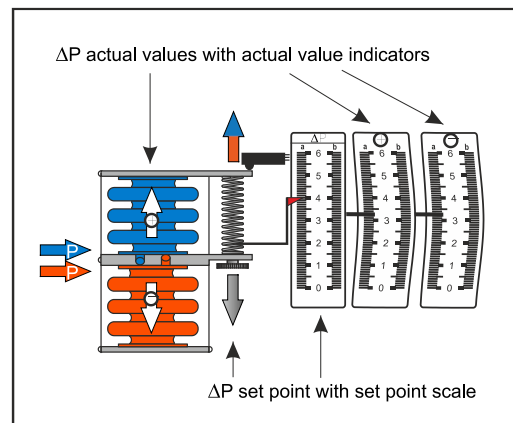







**Force-balance measuring system (ΔP)**

An adjustable tension or stress spring provides the set point.

Two bellows working against each other build the differential pressure ΔP (actual differential value) from two process pressures (actual value).









Once the actual differential value opposes the set point adjustment, force-balance-principle, a friction-free double-lever triggers an electric or pneumatic switching contact.

**PRODUCT MATRIX MANOCOMB® PRESSURE SWITCH**

			
Model	<b>MANOCOMB-IP65</b>	<b>MANOCOMB-IP65/CV</b>	<b>MANOCOMB-IP65/X...</b>
Function	mech. Pressure Switch/Monitor/ Safety Pressure Limiter	mech. Safety Pressure Limiter with internal interlock	mech. ATEX- Pressure Switch/ Monitor/Safety Pressure Limiter
Media	Allfluid	Allfluid	Allfluid
Switch contacts	micro switch or inductive contact or pneumatic valve	micro switch	micro switch (IP65/XI) EExd-micro switch (IP65/XD) pneumatic valve (IP65/PN)
No. of contacts	1 or 2	1	1 or 2
Setpoint accuracy	≤ 1% FS	≤ 1% FS	≤ 1% FS
hysteresis	≤ 1% FS <sup>1</sup>	not applicable, manual reset	≤ 1% FS <sup>1</sup>
wetted parts	brass or stainless steel 1.4571 (316Ti)	brass or stainless steel 1.4571 (316Ti)	brass or stainless steel 1.4571 (316Ti)
Enclosure	offshore-compatible plastic housing or aluminum	offshore-compatible plastic housing or aluminum	offshore-compatible plastic housing or aluminum
Pressure Ranges	-1...0 bar ... -60...0 mbar; 0 - 60 mbar ... 0 - 400 bar	0 - 1 bar ... 0 - 400 bar	-1...0 bar ... -60...0 mbar; 0 - 60 mbar ... 0 - 400 bar
Overpressure Safety	at least 1,5x FS	at least 1,5x FS	at least 1,5x FS
Vacuum Safety	-1 bar	-1 bar	-1 bar
Process connection	BSP thread connection acc. to EN837 or NPT or pipe or flange or chemical seal	BSP thread connection acc. to EN837 or NPT or pipe or flange or chemical seal	BSP thread connection acc. to EN837 or NPT or pipe or flange or chemical seal
Electrical Connection	terminal blocks/cable gland or plug ISO4400 / M12 / Harting	terminal blocks/cable gland or plug ISO4400 / M12 / Harting	terminal blocks/cable gland or plug ISO4400 / M12 / Harting / cable (XD) / 1/4" BSP male (PN)
Protection	IP65	IP65	IP65 Zone 1 and 2 / 21 and 22
Approvals			
Options	• integrated gauge	• integrated gauge	• integrated gauge
Catalogue page	10	16	20 - 29

<sup>1</sup> refers to standard micro switch - see catalogue page for further information



			
Model	<b>MANOCOMB-TM</b>	<b>MANOCOMB-IP54</b>	<b>MANOCOMB-96x96</b>
Function	mech. Pressure Switch/Monitor/ Safety Pressure Limiter	mech. Pressure Switch	mech. Pressure Switch for panel mounting
Media	Allfluid	Allfluid	Allfluid
Switch contacts	micro switch and analogue output	micro switch or inductive contact or air gap contact	micro switch or inductive contact
No. of contacts	1 or 2 (+1 Analogue output)	1 or 2	1 or 2
Setpoint accuracy	≤ 1% FS (analogue output: ≤ 0,5% FS)	≤ 1% FS	≤ 1% FS
hysteresis	≤ 1% FS <sup>1</sup>	≤ 1% FS <sup>1</sup>	≤ 1% FS <sup>1</sup>
wetted parts	ceramics (Al <sub>2</sub> O <sub>3</sub> ) and brass or stainless steel 1.4571 (316Ti)	brass or stainless steel 1.4571 (316Ti)	brass or stainless steel 1.4571 (316Ti)
Enclosure	offshore-compatible plastic housing or aluminum	offshore-compatible plastic housing	steel sheet, black
Pressure Ranges	-1...0 bar; 0 - 1 bar ... 0 - 400 bar	-1...0 bar ... -60...0 mbar; 0 - 60 mbar ... 0 - 400 bar	-1...0 bar ... -60...0 mbar; 0 - 60 mbar ... 0 - 400 bar
Overpressure Safety	at least 1,5x FS	at least 1,5x FS	at least 1,5x FS
Vacuum Safety	-1 bar	-1 bar	-1 bar
Process connection	BSP thread connection acc. to EN837 or NPT or pipe or flange or chemical seal	BSP thread connection acc. to EN837 or NPT or pipe or flange or chemical seal	BSP thread connection acc. to EN837
Electrical Connection	plug ISO4400	cable or plug ISO4400 / M12 / Harting / 1/4" BSP male (with air gap contact)	terminal blocks
Protection	IP65	IP65	IP65 (front facing)
Approvals	  		
Options	• integrated gauge	• integrated gauge	• integrated gauge
Catalogue page	30	36	40

## MANOCOMB® Precision Pressure Switch Model IP65



- friction-free force-balance measuring system
- very high repeatability
- extraordinary long-term stability
- measuring ranges from -1... 0 bar up to 0 - 400 bar
- comfortable setpoint adjustment on calibrated scale
- **optionally integrated pressure gauge**
- **approved as Pressure Monitor / Pressure Limiter**

### Description

The MANOCOMB®-IP65 is a precision pressure switch for measuring pressure, differential pressure and vacuum of gaseous or liquid, also aggressive, crystallizing and highly viscous media.

### Operating Principal

The operation is based on force-balance - per change-over contact a metal bellows is available, which is opposed by a precision spring with an adjustable force.

Once the process pressure overcomes the set force the change-over is triggered.

The contact adjustment is done by removing the cover and turning the thumb wheel to the desired set point.

The set point adjustment can be comfortably read from the set point scale. No reference instrument is needed.

The measuring system, which actuates the switching contact works friction-free, resulting in minimal wear. No maintenance or spare parts are needed!

### Integrated Pressure Gauge

The optionally integrated pressure gauge (class 1.0) visualizes the actual process pressure right next to the set point indicator.

### Approvals

SIL	Safety Integrity Level (IEC 61508/61511) SIL 2 and SIL 3*
VdTÜV	VdTÜV-leaflet Pressure 100 Pressure Monitor / Safety Pressure Limiter
DGR	Pressure Equipment Directive 97/23/EC Module B (test type approval) and D (QA)
DVGW	Gas Appliances Directive 90/396/EEC, EN1854, DIN DVGW 3398 P3, P4
GOST	GOST-R Certification Proof of Conformity with russian quality standards and regulations

\* SIL2: as a single device  
SIL3: in combination of 2 devices

Switching Function	Description
1K	1x change-over contact
1KA	1x change-over contact, 1x integrated gauge
2K	2x change-over contact
2KA	2x change-over contact, 1x integrated gauge
2KP	2x change-over contact, separate measuring systems
2K2AP	2x change-over contact, separate measuring systems with 1x integrated gauge each
1KPDi	1x change-over contact, differential pressure
1K2APDi	1x change-over contact, differential pressure, 2x integrated gauge - 1x for + und - inlet

Technical Data	Standard	Option
Function	mechanical pressure switch; force-balance measuring systems with bellows sensor	
Life Cycle	at least 10 Mio switch cycles	
Low Pressure Ranges	0 - 60 mbar; 0 - 100 mbar; 0 - 160 mbar; 0 - 250 mbar; 0 - 400 mbar; 0 - 600 mbar	
Pressure Ranges	0 - 1 bar; 0 - 1,6 bar; 0 - 2,5 bar; 0 - 4 bar; 0 - 6 bar; 0 - 10 bar; 0 - 16 bar; 0 - 25 bar; 0 - 40 bar; 0 - 60 bar	
High Pressure Ranges	0 - 100 bar; 0 - 160 bar; 0 - 250 bar; 0 - 400 bar	
Vacuum Ranges	-1...0 bar; -600...0 mbar; -400...0 mbar; -250...0 mbar; -160...0 mbar; -100...0 mbar; -60...0 mbar	
Over Pressure Safety	1,5x FS	
Vacuum Safety	-1 bar	
Housing Material	enhanced plastics with transparent cover	
Wetted Parts Material	brass	Stainless Steel 1.4571 (AISI 316Ti)
Permissible Media Temperature	-20...+80°C (+130°C in stainless steel version)	
Permissible Ambient Temperature	-20...+80°C	
Temperature Deviation	approx. 1% per 20°C	
Adjustment Temperature	20°C	on request
Switching Contact	1 or 2 switching contacts (SPDT) - for details see switching contacts overview	
Contact Adjustment Accuracy	≤ 1,0% FS	
Switching Differential (Hysteresis)	see switching contacts overview	
Repeatability	≤ 0,5% FS	
Accuracy of integrated Gauge	Class 1.0 (available for pressure range -1...0 bar / 0 - 1 bar...0 - 250 bar)	
Process Connection	1/4" BSP male (EN837)	1/2" BSP male (EN 837); others on request
Electrical Connection	M20 cable gland; terminal blocks inside housing for cable 2,5mm <sup>2</sup>	ISO 4400 plug; Harting HAN7D/8U plug
Weight	approx. 1.5 kg (depending on switching function)	
Protection	IP65	
<b>Other Options</b>		
Scales in different units (e.g. MPa, kPa, psi, etc.); Dual Scale; Customer specific Scales		
silicone free version; version for O2 service		

## DIMENSIONS

### MANOCOMB-IP65

Standard Version (1K, 1KA, 2K, 2KA)

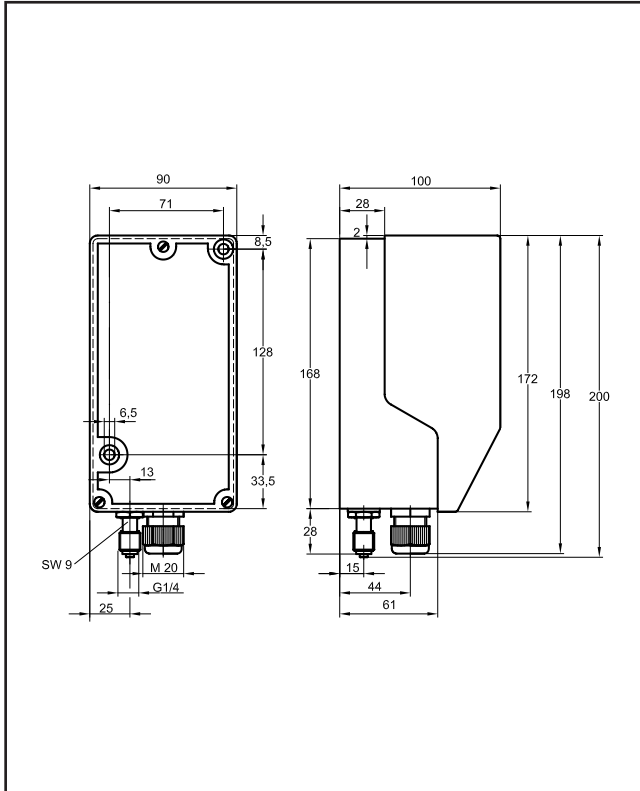

### MANOCOMB-IP65

Standard Version (2KP, 2K2AP, 1KPDi, 1K2APDi)

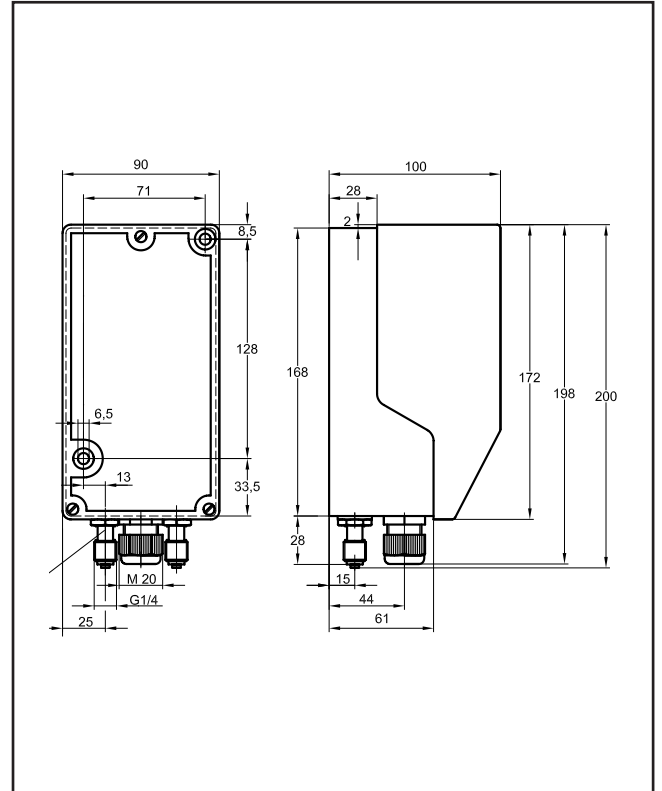

### MANOCOMB-IP65

with ISO 4400 (DIN 43650) plug

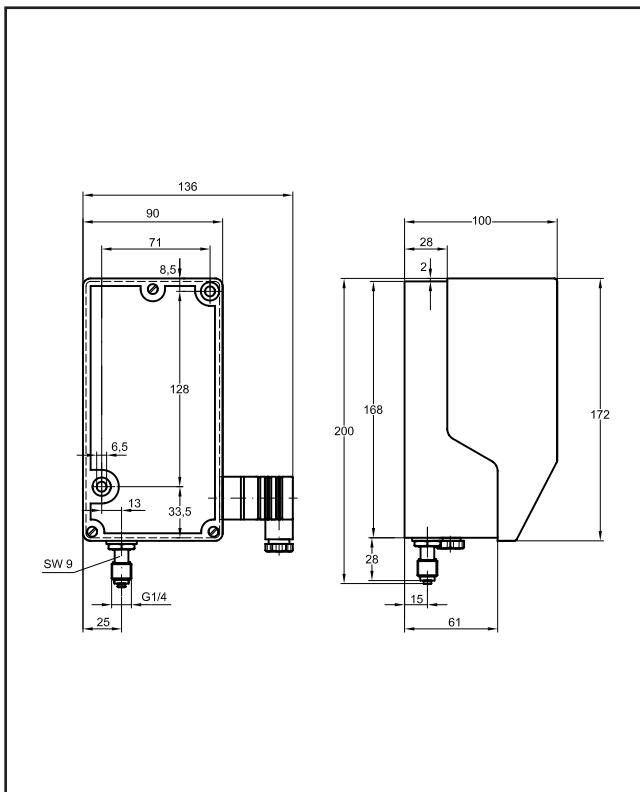

### MANOCOMB-IP65

process connection 1/2" BSP male and Harting plug

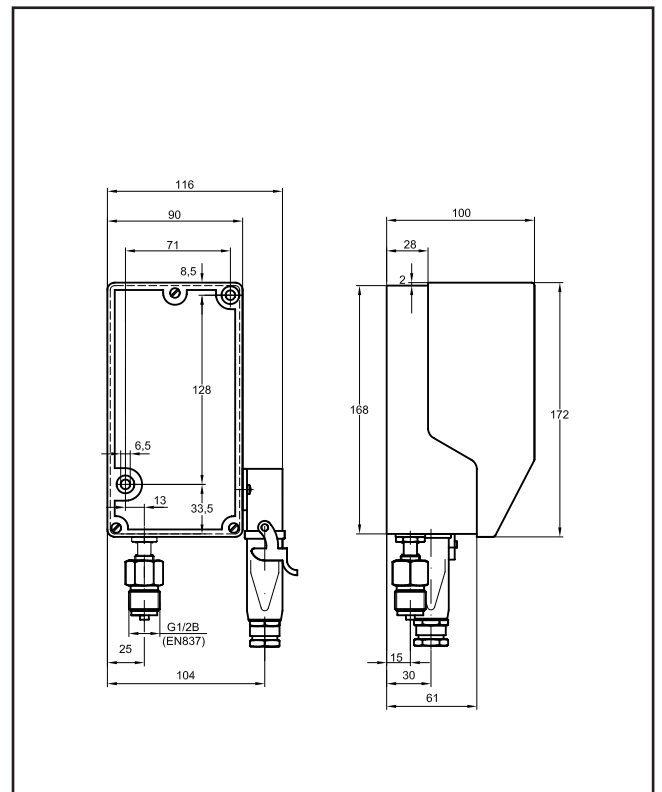

## SWITCHING CONTACTS

### Micro Switches

Type		24V	48V	110V	240V	SD <sup>1</sup>
Standard	A (AC)	5	5	5	5	≤ 1,0 %
	A (DC)	1	0,5	-	-	
MG <sup>2</sup>	A (AC)	1	1	1	-	≤ 1,5 %
	A (DC)	1	0,5	0,2	-	
MH	A (AC)	5	5	5	5	≤ 1,5 %
	A (DC)	1	0,5	-	-	
CS	A (AC)	5	5	5	5	≤ 2,0 %
	A (DC)	5	2	0,4	0,2	
CH	A (AC)	12	12	10	10	≤ 2,0 %
	A (DC)	10	2	0,4	0,2	
CZ <sup>3</sup>	A (AC)	5	5	5	5	≤ 2,0 %
	A (DC)	5	2	0,4	0,2	

### Inductive Contacts

Type	Function	Output polarity	SD <sup>1</sup>
I-N	NAMUR NC	NAMUR	≤ 1,0 %
I-SN	NAMUR NC	safety function	≤ 1,0 %
I-S1N	NAMUR NO	safety function	≤ 1,0 %

<sup>1</sup> typical switching differential (hysteresis) from 1 - 250 bar; Deviation in % of FS

<sup>2</sup> micro switch with gold-plated contacts

<sup>3</sup> micro switch with forced circuit opening

## ELECTRICAL CONNECTION<sup>1</sup>

shown in zero pressure condition

### Terminal Blocks

Pressure, Differential P.

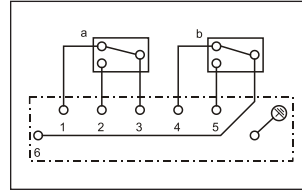

### Terminal Blocks

Vacuum

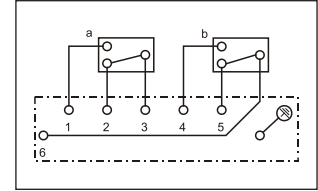

<sup>1</sup> standard wiring - customer specific wiring on request

## PRESSURE LIMITER

### External interlock

When used as a pressure limiter acc. to Vd-TÜV leaflet Pressure 100/1 the switch condition must be locked once the the pressure rises beyond the adjusted setpoint.

Before unlocking the interlock the reason for the pressure rise must be clarified and corrected.

Recommondations for an external interlock in a control cabinet or PLC:

#### interlock on rising pressure

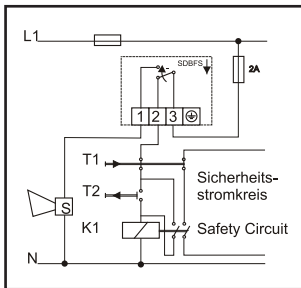

#### interlock on falling pressure

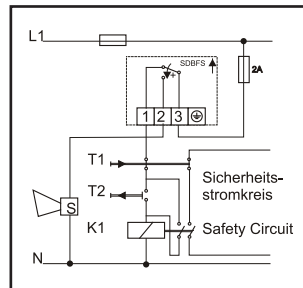

## PRESSURE LIMITER

### Internal interlock

Pressure limiters with internal interlock feature an integrated interlock.

With a manual reset on the device the interlock is re-opened

An external interlock is not necessary.

For pressure limiters with internal interlock please see MANOCOMB-IP65/CV on page 22.

## EXAMPLE CONFIGURATIONS

(pictures may show options)

MANOCOMB-IP65 0 - 10 bar  
with ISO 4400 (DIN 43650) plug



MANOCOMB-IP65 0 - 10 bar  
with Harting plug H8U + Diaphragm Seal Type FT

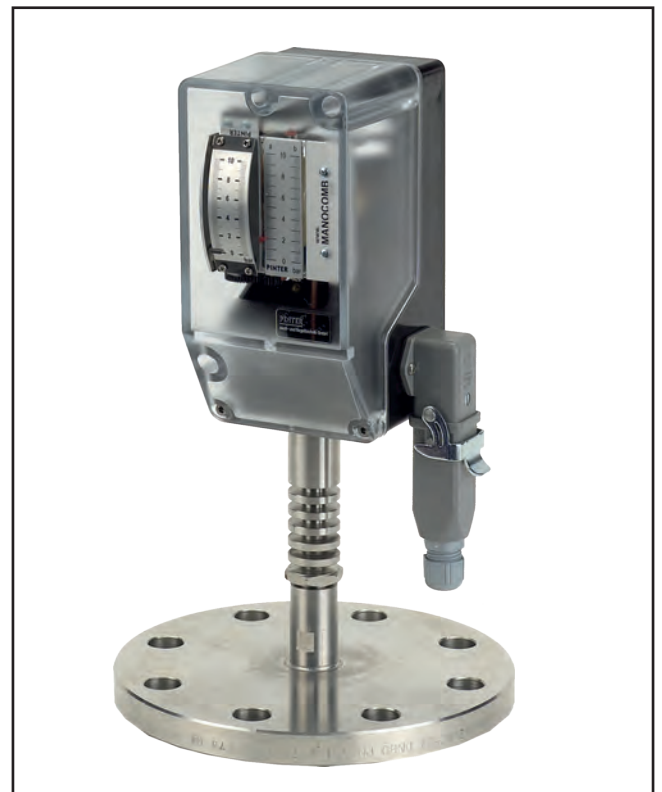

## ORDER CODES

(with most common options)

Order Code		M	0	x	x	x	x	-	x	(x)	-	x	x	x
Approvals	Standard			0										
	PED, TÜV, SIL, DVGW, GOST			1										
Switching Function	1K				0									
	1KA				1									
	2K				2									
	2KA				3									
	2KP				4									
	2K2AP				5									
	1KPDi				7									
	1K2APDi				8									
Material	brass													1
	Stainless Steel 1.4571 (AISI 316Ti)													2
Switching Contact	Standard													A
	MG													B
	MH													C
	CS													H
	CH													G
	CZ													3
	I-N													J
	I-SN													K
	I-S1N													W
Pressure Range	-1...0 bar													006
	-60...0 mbar													000
	0 - 60 mbar													010
	0 - 100 mbar													011
	0 - 160 mbar													012
	0 - 250 mbar													013
	0 - 400 mbar													014
	0 - 600 mbar													015
	0 - 1 bar													020
	0 - 1,6 bar													022
	0 - 2,5 bar													023
	0 - 4 bar													024
	0 - 6 bar													025
	0 - 10 bar													026
	0 - 16 bar													027
	0 - 25 bar													028
	0 - 40 bar													029
	0 - 60 bar													030
	0 - 100 bar													031
	0 - 160 bar													032
0 - 250 bar													033	
0 - 400 bar													035	
2. Pressure Range	differential pressure range or 2. pressure range on switching function 2K(2A)P codes as above; leave empty on other models													
Process Connection	G 1/4 B, brass													A
	G 1/4 B, Stainless Steel 1.4571 (AISI 316Ti)													B
	G 1/2 B, brass													C
	G 1/2 B, Stainless Steel 1.4571 (AISI 316Ti)													D
Electr. Connection	M20 cable gland; terminal blocks													A
	ISO 4400 plug													B
	Harting HAN7D plug													X
	Harting HAN8U plug													Z
Further Options	no further options													O
	cleaned for O2 service													A
	cover lead-sealable													W

## MANOCOMB® Precision Pressure Switch Model IP65/CV



- friction-free force-balance measuring system
- very high repeatability
- extraordinary long-term stability
- measuring ranges from -1... 0 bar up to 0 - 400 bar
- comfortable setpoint adjustment on calibrated scale
- **approved as Pressure Monitor / Pressure Limiter**
- **internal interlock of switch state**
- **for LOW or HIGH pressure or combined**
- **manual reset or tool reset or combined**

### Description

The MANOCOMB®-IP65 is a precision pressure switch for measuring pressure, differential pressure and vacuum of gaseous or liquid, also aggressive, chrySTALLIZING and highly viscous media.

### Operating Principal

The operation is based on force-balance - per change-over contact a metal bellows is available, which is opposed by a precision spring with an adjustable force.

Once the process pressure overcomes the set force the change-over is triggered.

The contact adjustment is done by removing the cover and turning the thumb wheel to the desired set point.

The set point adjustment can be comfortably read from the set point scale. No reference instrument is needed.

The measuring system, which actuates the switching contact works friction-free, resulting in minimal wear. No maintenance or spare parts are needed!

### Integrated Pressure Gauge

The optionally integrated pressure gauge (class 1.0) visualizes the actual process pressure right next to the set point indicator.

### Approvals

SIL	Safety Integrity Level (IEC 61508/61511) SIL 2 and SIL 3*
VdTÜV	VdTÜV-leaflet Druck 100 Pressure Monitor / Safety Pressure Limiter
PED	Pressure Equipment Directive 97/23/EC Modules B (type examination) and D (QA)
DVGW	Gas Appliances Directive 90/396/EEC, EN1854, DIN DVGW 3398 P3, P4
GOST	GOST-R certification proof of conformity with Russian quality standards and regulations

\* SIL2: as a single device / SIL3: in combination of 2 devices



Switching Function	Description
1K	1x change-over contact
1KA	1x change-over contact, 1x integrated gauge
2K	2x change-over contact
2KA	2x change-over contact, 1x integrated gauge
2KP	2x change-over contact, separate measuring systems
2K2AP	2x change-over contact, separate measuring systems with 1x integrated gauge each
1KPDi	1x change-over contact, differential pressure
1K2APDi	1x change-over contact, differential pressure, 2x integrated gauge - 1x for + und - inlet

Technical Data	Standard	Option
Function	mechanical pressure switch; force-balance measuring systems with bellows sensor	
Life Cycle	at least 10 Mio switch cycles	
Pressure Ranges	0 - 1 bar; 0 - 1,6 bar; 0 - 2,5 bar; 0 - 4 bar; 0 - 6 bar; 0 - 10 bar; 0 - 16 bar; 0 - 25 bar; 0 - 40 bar; 0 - 60 bar	
High Pressure Ranges	0 - 100 bar; 0 - 160 bar; 0 - 250 bar; 0 - 400 bar	
Differential Pressure	see pressure ranges max. ration between static and differential pressure 10:1; others on request	
Vacuum Ranges	-1...0 bar;	
Over Pressure Safety	1,5x FS	
Vacuum Safety	-1 bar	
Housing Material	reinforced plastics with transparent cover	
Wetted Parts Material	brass	Stainless Steel 1.4571 (AISI 316Ti)
Permissible Media Temperature	-20...+80°C (+130°C in stainless steel version)	
Permissible Ambient Temperature	-20...+80°C	
Temperature Deviation	approx. 1% per 20°C	
Adjustment Temperature	20°C	on request
Switching Contact	1 or 2 switching contacts for rising (HIGH) or falling (LOW) pressure or combined LOW and HIGH with internal interlock of switch state and manual reset and/or tool reset	
Contact Adjustment Accuracy	≤ 1,0% FS	
Switching Accuracy	see switching contacts overview	
Repeatability	manual reset	
Switching Differential (Hysteresis)	manual reset (resettierbar ab ca. 2% FS)	
Accuracy of integrated Gauge	Class 1.0 (available for pressure range -1...0 bar / 0 - 1 bar...0 - 250 bar)	
Process Connection	1/4" BSP male (EN837)	1/2" BSP male (EN 837); others on request
Electrical Connection	M20 cable gland; terminal blocks inside housing for cable 2,5mm <sup>2</sup>	ISO 4400 plug; Harting HAN7D/8U plug
Weight	approx. 1.5 kg (depending on switching function)	
Protection	IP65	
<b>Other Options</b>		
Scales in different units (e.g. MPa, kPa, psi, etc.); Dual Scale; Customer specific Scales		
silicone free version; version for O2 service		

## DIMENSIONS

MANOCOMB-IP65  
Standard Version (1K,1KA)

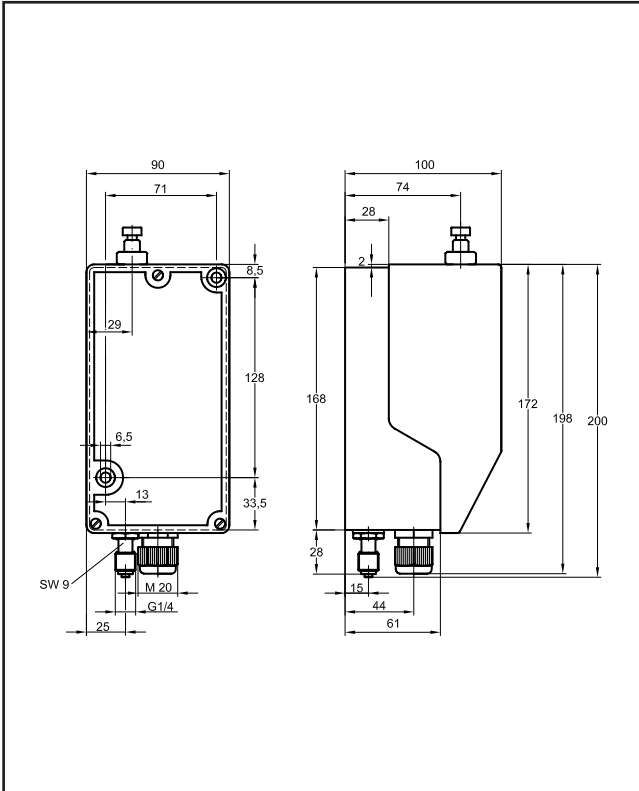

## SWITCHING CONTACTS

Micro Switches

Type		24V	48V	110V	240V
CV	A (AC)	5	5	5	5
	A (DC)	5	2	0,4	0,2

## ELECTRICAL CONNECTION<sup>1</sup>

shown in zero pressure condition

Terminal Blocks  
Pressure, Differential P.

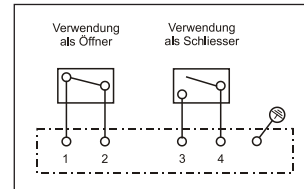

Terminal Blocks  
Vacuum

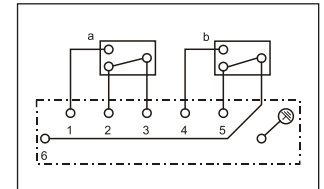

<sup>1</sup> standard wiring - customer specific wiring on request

## ORDER CODES

(with most common options)

Order Code		M	0	V	x	x	x	-	x	(x)	-	x	x	x	
DGR, TÜV, SIL, DVGW, GOST				V											
Switching Function	1K				0										
	1KA				1										
	2K				2										
	2KA				3										
	2KP				4										
	2K2AP				5										
	1KPDi				7										
	1K2APDi				8										
Material	brass					1									
	Stainless Steel 1.4571 (AISI 316Ti)					2									
interlock configuration	manual reset	HIGH pressure with internal interlock					A								
		LOW pressure with internal interlock					B								
		1x HIGH and 1x LOW pressure with internal interlock (2K versions)					C								
	tool reset	HIGH pressure with internal interlock					D								
		LOW pressure with internal interlock					E								
		1x HIGH and 1x LOW pressure with internal interlock (2K versions)					F								
	combined reset	1x HIGH pressure with internal interlock and manual reset 1x HIGH pressure with internal interlock and tool reset (2K version)					G								
		1x LOW pressure with internal interlock and manual reset 1x LOW pressure with internal interlock and tool reset (2K version)					H								
		1x HIGH pressure with internal interlock and manual reset 1x LOW pressure with internal interlock and tool reset (2K version)					I								
		1x HIGH pressure with internal interlock and tool reset 1x LOW pressure with internal interlock and manual reset (2K version)					J								
	Pressure Range	-1...0 bar								006					
0 - 1 bar								020							
0 - 1,6 bar								022							
0 - 2,5 bar								023							
0 - 4 bar								024							
0 - 6 bar								025							
0 - 10 bar								026							
0 - 16 bar								027							
0 - 25 bar								028							
0 - 40 bar								029							
0 - 60 bar								030							
0 - 100 bar								031							
0 - 160 bar								032							
0 - 250 bar								033							
0 - 400 bar								035							
2. Pressure Range	stating differential pressure range or 2. pressure range on switching function 2K(2A)P codes as above; leave empty on other models														
Process Connection	G 1/4 B, brass											A			
	G 1/4 B, Stainless Steel 1.4571 (AISI 316Ti)											B			
	G 1/2 B, brass											C			
	G 1/2 B, Stainless Steel 1.4571 (AISI 316Ti)											D			
Electr. Connection	M20 cable gland; terminal blocks												A		
	ISO 4400 plug												B		
	Harting HAN7D plug												X		
	Harting HAN8U plug												Z		
Further Options	no further options													O	
	cleaned for O2 service													A	
	cover lead-sealable													W	
	47 kOhm resistor													AL	

## MANOCOMB® Precision Pressure Switch Model IP65/XI



- friction-free force-balance measuring system
- very high repeatability
- extraordinary long-term stability
- measuring ranges from -1... 0 bar up to 0 - 400 bar
- comfortable setpoint adjustment on calibrated scale
- **optionally integrated pressure gauge**
- **approved as Pressure Monitor / Pressure Limiter**
- **for hazardous area (Exi)**

### Description

The MANOCOMB®-IP65/XI is a precision pressure switch for measuring pressure, differential pressure and vacuum of gaseous or liquid, also crystallizing and highly viscous media. Especially for hazardous area.

### Operating Principal

The operation is based on force-balance - per change-over contact a metal bellows is available, which is opposed by a precision spring with an adjustable force.

Once the process pressure overcomes the set force the change-over is triggered.

The contact adjustment is done by removing the cover and turning the thumb wheel to the desired set point.

The set point adjustment can be comfortably read from the set point scale. No reference instrument is needed.

The measuring system, which actuates the switching contact works friction-free, resulting in minimal wear. No maintenance or spare parts are needed!

### Integrated Pressure Gauge

The optionally integrated pressure gauge (class 1.0) visualizes the actual process pressure right next to the set point indicator.

### Approvals

SIL	Safety Integrity Level (IEC 61508/61511) SIL 2 and SIL 3*
VdTÜV	VdTÜV-leaflet Druck 100 Pressure Monitor / Safety Pressure Limiter
PED	Pressure Equipment Directive 97/23/EC Modules B (type examination) and D (QA)
DVGW	Gas Appliances Directive 90/396/EEC, EN1854, DIN DVGW 3398 P3, P4
ATEX	ATEX-Directive 94/9/EC Zone 1 and 2 / Zone 21 and 22
GOST	GOST-R Certification Proof of Conformity with russian quality standards and regulations

\* SIL2: as a single device / SIL3: in combination of 2 devices

Switching Function	Description
1K	1x change-over contact
1KA	1x change-over contact, 1x integrated gauge
2K	2x change-over contact
2KA	2x change-over contact, 1x integrated gauge
2KP	2x change-over contact, separate measuring systems
2K2AP	2x change-over contact, separate measuring systems with 1x integrated gauge each
1KPDi	1x change-over contact, differential pressure
1K2APDi	1x change-over contact, differential pressure, 2x integrated gauge - 1x for + und - inlet

Technical Data	Standard	Option
Function	mechanical pressure switch; force-balance measuring systems with bellows sensor	
Life Cycle	at least 10 Mio switch cycles	
Low Pressure Ranges	0 - 60 mbar; 0 - 100 mbar; 0 - 160 mbar; 0 - 250 mbar; 0 - 400 mbar; 0 - 600 mbar	
Pressure Ranges	0 - 1 bar; 0 - 1,6 bar; 0 - 2,5 bar; 0 - 4 bar; 0 - 6 bar; 0 - 10 bar; 0 - 16 bar; 0 - 25 bar; 0 - 40 bar; 0 - 60 bar	
High Pressure Ranges	0 - 100 bar; 0 - 160 bar; 0 - 250 bar; 0 - 400 bar	
Vacuum Ranges	-1...0 bar; -600...0 mbar; -400...0 mbar; -250...0 mbar; -160...0 mbar; -100...0 mbar; -60...0 mbar	
Over Pressure Safety	1,5x FS	
Vacuum Safety	-1 bar	
Housing Material	enhanced plastics with transparent cover	Aluminium
Wetted Parts Material	brass	Stainless Steel 1.4571 (AISI 316Ti)
Permissible Media Temperature	-20...+80°C (+130°C in stainless steel version)	
Permissible Ambient Temperature	-20...+80°C	
Temperature Deviation	approx. 1% per 20°C	
Adjustment Temperature	20°C	on request
Switching Contact	1 or 2 switching contacts (SPDT) - for details see switching contacts overview	
Switching Accuracy	≤ 1,0% FS	
Switching Differential (Hysteresis)	see switching contacts overview	
Repeatability	≤ 0,5% FS	
Accuracy of integrated Gauge	Class 1.0 (available for pressure range -1...0 bar / 0 - 1 bar...0 - 250 bar)	
Process Connection	1/4" BSP male (EN837)	1/2" BSP male (EN 837); others on request
Electrical Connection	M20 cable gland; terminal blocks inside housing for cable 2,5mm <sup>2</sup>	ISO 4400 plug; Harting HAN7D/8U plug
Weight	approx. 1.5 kg (depending on switching function)	
Protection	IP65	
<b>Other Options</b>		
Scales in different units (e.g. MPa, kPa, psi, etc.); Dual Scale; Customer specific Scales		
silicone free version; version for O2 service		

## DIMENSIONS

### MANOCOMB-IP65/XI Standard Version

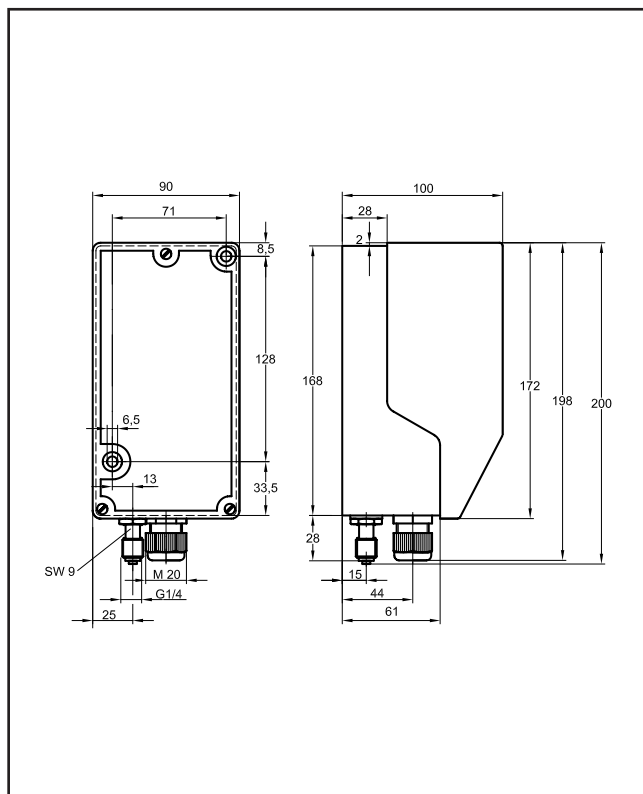

### MANOCOMB-IP65/XI Standard Version with Aluminium Housing

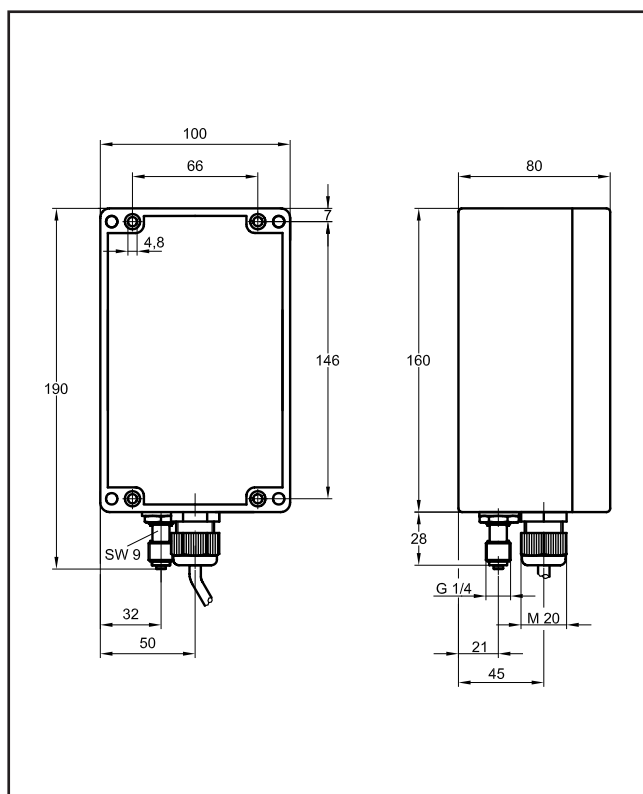

## SWITCHING CONTACTS

### Microswitches

Type		24V	48V	110V	240V	SD <sup>1</sup>
Standard	A (AC)	5	5	5	5	≤ 1,0 %
	A (DC)	1	0,5	-	-	
MG <sup>2</sup>	A (AC)	1	1	1	-	≤ 1,5 %
	A (DC)	1	0,5	0,2	-	

<sup>1</sup> typical switching differential (hysteresis) from 1 - 250 bar; Deviation in % of FS

<sup>2</sup> micro switch with gold-plated contacts

<sup>3</sup> micro switch with forced circuit opening

## ELECTRICAL CONNECTION

shown in zero-pressure condition

### Terminal Blocks

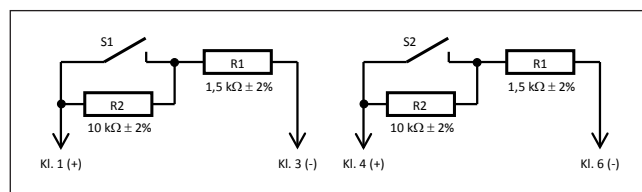

<sup>1</sup> standard wiring - customer specific wiring on request

## SWITCH AMPLIFIER

The pressure signal is evaluated via a micro switch (simple electrical apparatus) which must be connected to an approved intrinsically safe circuit of an associated electrical equipment, e.g. switch amplifier.

Please contact our sales team for recommended switch amplifiers.

## PRESSURE LIMITER

External interlock

When used as a pressure limiter acc. to Vd-TÜV leaflet Pressure 100/1 the switch condition must be locked once the the pressure rises beyond the adjusted setpoint.

Before unlocking the interlock the reason for the pressure rise must be clarified and corrected. Please contact our sales team for recommended external interlock.

## PRESSURE LIMITER

Internal interlock

Pressure limiters with internal interlock feature an integrated interlock.

With a manual reset on the device the interlock is re-opened

An external interlock is not necessary.

For pressure limiters with internal interlock please see MANOCOMB-IP65/CV on page 16.

## ORDER CODES

(with most common options)

Order Code		M	0	I	x	x	x	-	x	(x)	-	x	x	x
Switching Function	1K				0									
	1KA				1									
	2K				2									
	2KA				3									
	2KP				4									
	2K2AP				5									
	1KPDi				7									
	1K2APDi				8									
Material	Brass					1								
	Stainless Steel					2								
Switching Contact	Standard												A	
	MG												B	
Pressure Range	-1...0 bar													006
	-60...0 mbar													000
	0 - 60 mbar													010
	0 - 100 mbar													011
	0 - 160 mbar													012
	0 - 250 mbar													013
	0 - 400 mbar													014
	0 - 600 mbar													015
	0 - 1 bar													020
	0 - 1,6 bar													022
	0 - 2,5 bar													023
	0 - 4 bar													024
	0 - 6 bar													025
	0 - 10 bar													026
	0 - 16 bar													027
	0 - 25 bar													028
	0 - 40 bar													029
	0 - 60 bar													030
0 - 100 bar													031	
0 - 160 bar													032	
0 - 250 bar													033	
0 - 400 bar													035	
2. Pressure Range	differential pressure range or 2. pressure range on switching function 2K(2A)P codes as above; leave empty on other models													
Process Connection	1/4" BSP male, brass													A
	1/4" BSP male, stainless steel													B
	1/2" BSP male, brass													C
	1/2" BSP male, stainless steel													D
Electr. Connection	M20 cable gland; terminal blocks													A
	ISO 4400 plug													B
	Harting HAN7D plug													X
	Harting HAN8U plug													Z
Further Options	no further options													O
	cleaned for O2 service													A
	cover lead-sealable													W

## MANOCOMB® Precision Pressure Switch Model IP65/XD



- friction-free force-balance measuring system
- very high repeatability
- extraordinary long-term stability
- measuring ranges from -1... 0 bar up to 0 - 400 bar
- comfortable setpoint adjustment on calibrated scale
- **optionally integrated pressure gauge**
- **approved as Pressure Monitor / Pressure Limiter**
- **for hazardous area (EExd)**

### Description

The MANOCOMB®-IP65/XD is a precision pressure switch for measuring pressure, differential pressure and vacuum of gaseous or liquid, also crystallizing and highly viscous media. Especially for hazardous area.

### Operating Principal

The operation is based on force-balance - per change-over contact a metal bellows is available, which is opposed by a precision spring with an adjustable force.

Once the process pressure overcomes the set force the change-over is triggered.

The contact adjustment is done by removing the cover and turning the thumb wheel to the desired set point.

The set point adjustment can be comfortably read from the set point scale. No reference instrument is needed.

The measuring system, which actuates the switching contact works friction-free, resulting in minimal wear. No maintenance or spare parts are needed!

### Integrated Pressure Gauge

The optionally integrated pressure gauge (class 1.0) visualizes the actual process pressure right next to the set point indicator.

### Approvals

SIL	Safety Integrity Level (IEC 61508/61511) SIL 2 and SIL 3*
VdTÜV	VdTÜV-leaflet Druck 100 Pressure Monitor / Safety Pressure Limiter
PED	Pressure Equipment Directive 97/23/EC Modules B (type examination) and D (QA)
DVGW	Gas Appliances Directive 90/396/EEC, EN1854, DIN DVGW 3398 P3, P4
ATEX	ATEX-Directive 94/9/EC Zone 1 and 2 / Zone 21 and 22
GOST	GOST-R Certification Proof of Conformity with russian quality standards and regulations

\* SIL2: as a single device / SIL3: in combination of 2 devices



Switching Function	Description
1K	1x change-over contact
1KA	1x change-over contact, 1x integrated gauge
2K	2x change-over contact
2KA	2x change-over contact, 1x integrated gauge
2KP	2x change-over contact, separate measuring systems
2K2AP	2x change-over contact, separate measuring systems with 1x integrated gauge each
1KPDi	1x change-over contact, differential pressure
1K2APDi	1x change-over contact, differential pressure, 1x integrated gauge for + und - inlet

Technical Data	Standard	Option
Function	mechanical pressure switch; force-balance measuring systems with bellows sensor	
Life Cycle	at least 10 Mio switch cycles	
Low Pressure Ranges	0 - 60 mbar; 0 - 100 mbar; 0 - 160 mbar; 0 - 250 mbar; 0 - 400 mbar; 0 - 600 mbar	
Pressure Ranges	0 - 1 bar; 0 - 1,6 bar; 0 - 2,5 bar; 0 - 4 bar; 0 - 6 bar; 0 - 10 bar; 0 - 16 bar; 0 - 25 bar; 0 - 40 bar; 0 - 60 bar	
High Pressure Ranges	0 - 100 bar; 0 - 160 bar; 0 - 250 bar; 0 - 400 bar	
Vacuum Ranges	-1...0 bar; -600...0 mbar; -400...0 mbar; -250...0 mbar; -160...0 mbar; -100...0 mbar; -60...0 mbar	
Over Pressure Safety	1,5x FS	
Vacuum Safety	-1 bar	
Housing Material	enhanced plastics with transparent cover	Aluminium
Wetted Parts Material	brass	Stainless Steel 1.4571 (AISI 316Ti)
Permissible Media Temperature	-20...+80°C (+130°C in stainless steel version)	
Permissible Ambient Temperature	-20...+80°C	
Temperature Deviation	approx. 1% per 20°C	
Adjustment Temperature	20°C	on request
Switching Contact	1 or 2 switching contacts (SPDT) - for details see switching contacts overview	
Switching Accuracy	≤ 1,0% FS	
Switching Differential (Hysteresis)	see electrical data	
Repeatability	≤ 0,5% FS	
Accuracy of integrated Gauge	Class 1.0 (available for pressure range -1...0 bar / 0 - 1 bar...0 - 250 bar)	
Process Connection	1/4" BSP male (EN837)	1/2" BSP male (EN 837); others on request
Electrical Connection	3m cable	
Weight	approx. 1.5 kg (depending on switching function)	
Protection	IP65	
<b>Other Options</b>		
Scales in different units (e.g. MPa, kPa, psi, etc.); Dual Scale; Customer specific Scales		
silicone free version; version for O2 service		

## EINBAUMASSE

### MANOCOMB-IP65/XD Standard Version

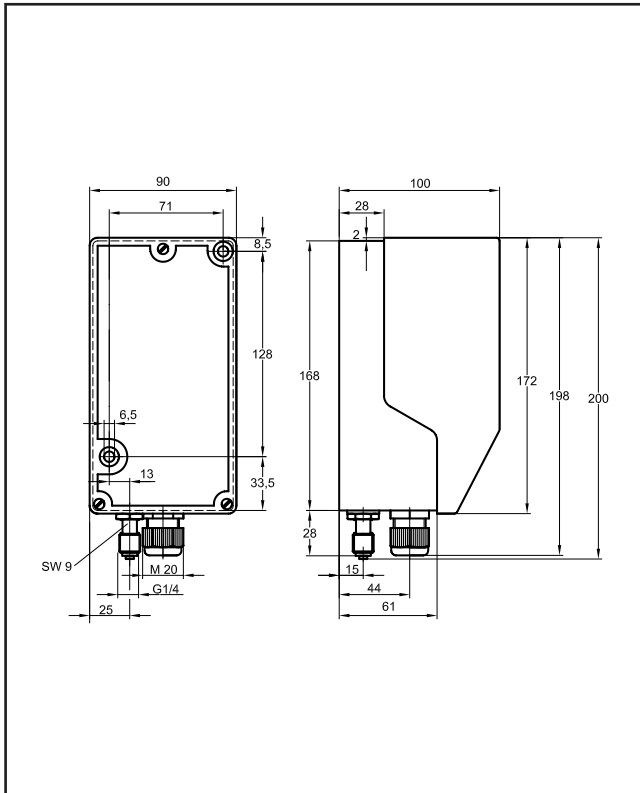

### MANOCOMB-IP65/XD Standard Version with Aluminium Housing

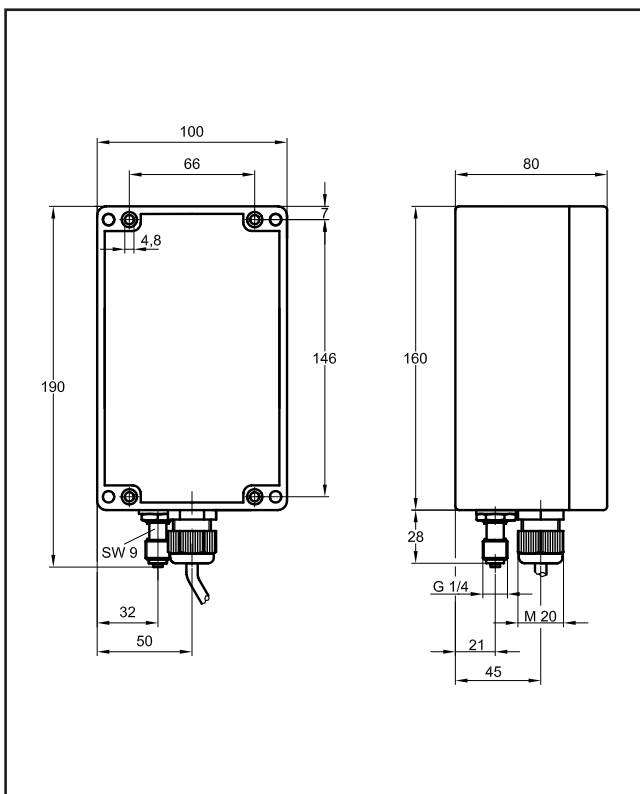

## SWITCHING CONTACTS

### Micro switch

Type		24V	48V	110V	240V	400V	SD <sup>1</sup>
BT	A (AC)	5	5	5	5	---	≤ 1,0 %
	A (DC)	5	1	0,5	0,25	---	
ST <sup>2</sup>	A (AC)	7	5	5	5	3	≤ 1,5 %
	A (DC)	7	0,4	0,4	0,4	---	

<sup>1</sup> typical switching differential (hysteresis) from 1 - 250 bar; Deviation in % of FS  
<sup>2</sup> for pressure ranges > 0 - 6 bar

## ELECTRICAL CONNECTION

shown in zero-pressure condition

### Cable

Pressure, Differential Pressure

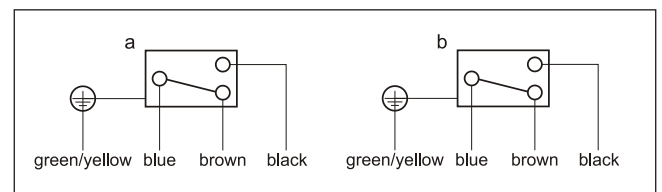

### Cable

Vacuum

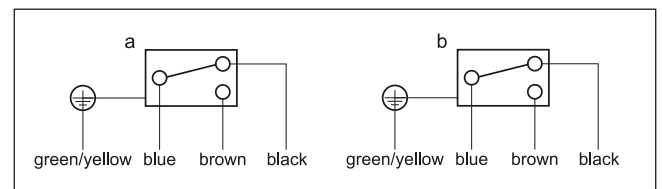

## PRESSURE LIMITER

External interlock

When used as a pressure limiter acc. to Vd-TÜV leaflet Pressure 100/1 the switch condition must be locked once the the pressure rises beyond the adjusted setpoint.

Before unlocking the interlock the reason for the pressure rise must be clarified and corrected. Please contact our sales team for recommended external interlock.

## PRESSURE LIMITER

Internal interlock

Pressure limiters with internal interlock feature an integrated interlock.

With a manual reset on the device the interlock is re-opened

An external interlock is not necessary.

For pressure limiters with internal interlock please see MANOCOMB-IP65/CV on page 16.

## ORDER CODES

(with most common options)

Order Code	M	0	D	x	x	x	-	x	(x)	-	x	K	x
Switching Function	1K			0									
	1KA			1									
	2K			2									
	2KA			3									
	2KP			4									
	2K2AP			5									
	1KPDi			7									
	1K2APDi			8									
Material	Brass				1								
	Stainless Steel				2								
Switching Contact	BT					4							
	ST					X							
Pressure Range	-1...0 bar								006				
	-60...0 mbar								000				
	0 - 60 mbar								010				
	0 - 100 mbar								011				
	0 - 160 mbar								012				
	0 - 250 mbar								013				
	0 - 400 mbar								014				
	0 - 600 mbar								015				
	0 - 1 bar								020				
	0 - 1,6 bar								022				
	0 - 2,5 bar								023				
	0 - 4 bar								024				
	0 - 6 bar								025				
	0 - 10 bar								026				
	0 - 16 bar								027				
	0 - 25 bar								028				
	0 - 40 bar								029				
	0 - 60 bar								030				
	0 - 100 bar								031				
	0 - 160 bar								032				
0 - 250 bar								033					
0 - 400 bar								035					
2. Pressure Range	differential pressure range or 2. pressure range on switching function 2K(2A)P codes as above; leave empty on other models												
Process Connection	1/4" BSP male, brass										A		
	1/4" BSP male, stainless steel										B		
	1/2" BSP male, brass										C		
	1/2" BSP male, stainless steel										D		
Further Options	no further options												O
	cleaned for O2 service												A
	cover lead-sealable												W

## MANOCOMB® Precision Pressure Switch Model IP65/PN



- friction-free force-balance measuring system
- very high repeatability
- extraordinary long-term stability
- measuring ranges from -1... 0 bar up to 0 - 400 bar
- comfortable setpoint adjustment on calibrated scale
- **optionally integrated pressure gauge**
- **approved as Pressure Monitor / Pressure Limiter**
- **for hazardous area (EEx - pneumatic)**

### Description

The MANOCOMB®-IP65/PN is a precision pressure switch for measuring pressure, differential pressure and vacuum of gaseous or liquid, also crystallizing and highly viscous media. Especially for hazardous area.

### Operating Principal

The operation is based on force-balance - per change-over contact a metal bellows is available, which is opposed by a precision spring with an adjustable force.

Once the process pressure overcomes the set force the change-over is triggered.

The contact adjustment is done by removing the cover and turning the thumb wheel to the desired set point.

The set point adjustment can be comfortably read from the set point scale. No reference instrument is needed.

The measuring system, which actuates the switching contact works friction-free, resulting in minimal wear. No maintenance or spare parts are needed!

### Integrated Pressure Gauge

The optionally integrated pressure gauge (class 1.0) visualizes the actual process pressure right next to the set point indicator.

### Approvals

SIL	Safety Integrity Level (IEC 61508/61511) SIL 2 and SIL 3*
VdTÜV	VdTÜV-leaflet Druck 100 Pressure Monitor / Safety Pressure Limiter
PED	Pressure Equipment Directive 97/23/EC Modules B (type examination) and D (QA)
DVGW	Gas Appliances Directive 90/396/EEC, EN1854, DIN DVGW 3398 P3, P4
ATEX	ATEX-Directive 94/9/EC Zone 1 and 2 / Zone 21 and 22
GOST	GOST-R Certification Proof of Conformity with russian quality standards and regulations

\* SIL2: as a single device / SIL3: in combination of 2 devices

Switching Function	Description
1K	1x pneumatic contact
1KA	1x pneumatic contact, 1x integrated gauge
2K	2x pneumatic contact
2KA	2x pneumatic contact, 1x integrated gauge
2KP	2x pneumatic contact, seperate measuring systems
2K2AP	2x pneumatic contact, seperate measuring systems with 1x integrated gauge each
1KPDi	1x pneumatic contact, differential pressure
1K2APDi	1x pneumatic contact, differential pressure, 2x integrated gauge - 1x for + und - inlet

Technical Data	Standard	Option
Function	mechanical pressure switch; force-balance measuring systems with bellows sensor	
Life Cycle	at least 10 Mio switch cycles	
Pressure Ranges	0 - 1 bar; 0 - 1,6 bar; 0 - 2,5 bar; 0 - 4 bar; 0 - 6 bar; 0 - 10 bar; 0 - 16 bar; 0 - 25 bar; 0 - 40 bar; 0 - 60 bar	
High Pressure Ranges	0 - 100 bar; 0 - 160 bar; 0 - 250 bar; 0 - 400 bar	
Vacuum Ranges	-1...0 bar	
Over Pressure Safety	1,5x FS	
Vacuum Safety	-1 bar	
Housing Material	enhanced plastics with transparent cover	coated aluminium
Wetted Parts Material	brass	Stainless Steel 1.4571 (AISI 316Ti)
Permissible Media Temperature	-20...+70°C	
Permissible Ambient Temperature	-20...+70°C	
Temperature Deviation	approx. 1% per 20°C	
Adjustment Temperature	20°C	on request
Swicthing Contact	1 or 2 pneumatic contacts (normally open or normally closed)	
Contact Adjustment Accuracy	≤ 1,0% FS	
Switching Differential (Hysteresis)	approx. 3 - 4% FS (depending on supply air pressure)	
Repeatability	≤ 0,5% FS	
Accuracy of integrated Gauge	Class 1.0 (available for pressure range -1...0 bar / 0 - 1 bar...0 - 250 bar)	
Process Connection	1/4" BSP male (EN837)	1/2" BSP male (EN837); others on request
Pneumatic Connection	quick connector for hose Ø6 mm	1/4" BSP male (EN837)
Supply Air Pressure	4 bar	on request
Supply Air Media	5 µm, oiled or filtered non oiled compressed air or any other non-explosive gasous media acc. to ISO-VG 10	
Weight	approx. 1.5 kg (depending on switching function)	
Protection	IP65	
<b>Other Options</b>		
Scales in different units (e.g. MPa, kPa, psi, etc.); Dual Scale; Customer specific Scales		
silicone free version; version for O2 service		

## DIMENSIONS

### MANOCOMB-IP65/PN Standard Version

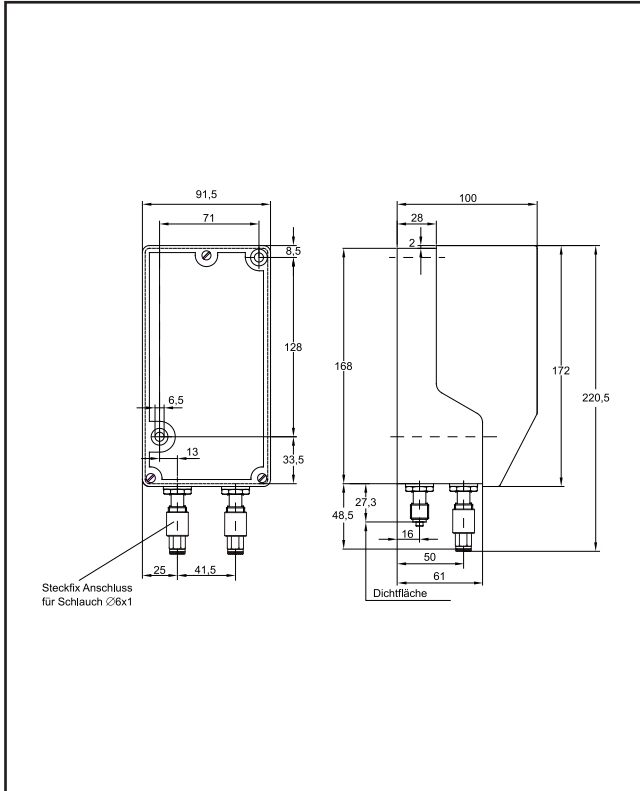

## PNEUMATIC DATA

Supply Air Pressure	2 - 8 bar (4 bar recommended)
Pneumatic Contact	3/2-way valve
Sealing	NBR
Consumption	approx. 0,7 l/min
Media	5 $\mu\text{m}$ , oiled or filtered non oiled compressed air or any other non-explosive gaseous media acc. to ISO-VG 10

## PNEUMATIC CONNECTION

shown in zero-pressure condition

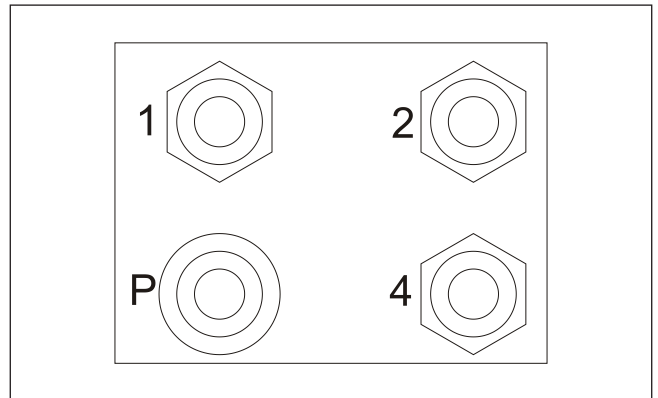

P	Process Connection
1	Supply Air Inlet
2	Control Air Outlet I
4	Control Air Outlet II <sup>1</sup>

<sup>1</sup> only on 2K(A) / 2K(2A)P versions

## PRESSURE LIMITER

External interlock

When used as a pressure limiter acc. to Vd-TÜV leaflet Pressure 100/1 the switch condition must be locked once the the pressure rises beyond the adjusted setpoint.

Before unlocking the interlock the reason for the pressure rise must be clarified and corrected. Please contact our sales team for recommended external interlock.

## PRESSURE LIMITER

Internal interlock

Pressure limiters with internal interlock feature an integrated interlock.

With a manual reset on the device the interlock is re-opened

An external interlock is not necessary.

For pressure limiters with internal interlock please see MANOCOMB-IP65/CV on page 16.

## ORDER CODES

(with most common options)

Order Code		M	0	P	x	x	x	-	x	(x)	-	x	K	x
Switching Function	1K				0									
	1KA				1									
	2K				2									
	2KA				3									
	2KP				4									
	2K2AP				5									
	1KPDi				7									
	1K2APDi				8									
Material	brass					1								
	stainless steel					2								
Switching Contact	pneumatic contact NO (normally open)												Q	
	pneumatic contact NC (normally closed)												R	
	1x NO + 1x NC (only 2K(A), 2K(2A)P)												6	
Pressure Range	-1...0 bar													006
	0 - 1 bar													020
	0 - 1,6 bar													022
	0 - 2,5 bar													023
	0 - 4 bar													024
	0 - 6 bar													025
	0 - 10 bar													026
	0 - 16 bar													027
	0 - 25 bar													028
	0 - 40 bar													029
	0 - 60 bar													030
	0 - 100 bar													031
	0 - 160 bar													032
	0 - 250 bar													033
	0 - 400 bar													035
2nd Pressure Range	2nd Pressure Range for 2K(2A)P / Differential Pressure Range for 1K(2A)PDi as above; otherwise leave blank.													
Process Connection	G 1/4 B, brass													A
	G 1/4 B, stainless steel													B
	G 1/2 B, brass													C
	G 1/2 B, stainless steel													D
Pneumatic Connection	quick connector for hose Ø6 mm													T
	G1/4 B (EN 837)													5
Further Options	no further options													O
	cleaned for O2 service													A
	cover lead-sealable													W

## MANOCOMB® Precision Pressure Switch Model TM smart measuring



- friction-free force-balance measuring system
- very high repeatability
- extraordinary long-term stability
- measuring ranges from -1... 0 bar up to 0 - 400 bar
- comfortable setpoint adjustment on calibrated scale
- **integrated pressure transmitter**
- **optionally integrated pressure gauge**
- **approved as Pressure Monitor / Pressure Limiter**

### Description

The MANOCOMB®-TM is a precision pressure switch for measuring pressure, differential pressure and vacuum of gaseous or liquid, also aggressive, crystallizing and highly viscous media.

### Operating Principle

The operation is based on force-balance - per change-over contact a metal bellows is available, which is opposed by a precision spring with an adjustable force.

Once the process pressure overcomes the set force the change-over is triggered.

The contact adjustment is done by removing the cover and turning the thumb wheel to the desired set point.

The set point adjustment can be comfortably read from the set point scale. No reference instrument is needed.

The measuring system, which actuates the switching contact works friction-free, resulting in minimal wear. No maintenance or spare parts are needed!

### Integrated Pressure Transmitter / Integrated Pressure Gauge

The integrated pressure transmitter (0,5% FS) delivers a continuous output signal (4 - 20 mA or 0 - 10V).

The optionally integrated pressure gauge (class 1.0) visualizes the actual process pressure right next to the set point indicator.

### Approvals

VdTÜV

PED

GOST

VdTÜV-leaflet Druck 100  
Pressure Monitor / Safety Pressure Limiter

Pressure Equipment Directive 97/23/EC  
Modules B (type examination) and D (QA)

GOST-R Certification  
Proof of Conformity with russian quality standards and regulations



Schaltfunktionen	Beschreibung
1K	1x change-over contact, 1x analogue output
1KA	1x change-over contact, 1x analogue output, 1x integrated gauge
2K	2x change-over contact, 1x analogue output
2KA	2x change-over contact, 1x analogue output, 1x integrated gauge

Technical Data	Standard	Option
Function	mechanical pressure switch; force-balance measuring systems with bellows sensor; with integrated analogue output	
Life Cycle	at least 10 Mio switch cycles	
Pressure Ranges	0 - 1 bar; 0 - 1,6 bar; 0 - 2,5 bar; 0 - 4 bar; 0 - 6 bar; 0 - 10 bar; 0 - 16 bar; 0 - 25 bar; 0 - 40 bar; 0 - 60 bar	
High Pressure Ranges	0 - 100 bar; 0 - 160 bar; 0 - 250 bar; 0 - 400 bar	
Vacuum Ranges	-1...0 bar	
Integrated Pressure Transmitter	pressure ranges available as relative pressure or absolute pressure (up to 40 bar)	
Over Pressure Safety	1,5x FS	
Vacuum Safety	-1 bar	
Housing Material	enhanced plastics with transparent cover	
Wetted Parts Material	brass, Al <sub>2</sub> O <sub>3</sub>	Stainless Steel 1.4571 (AISI 316Ti), Al <sub>2</sub> O <sub>3</sub>
Permissible Media Temperature	-20...+80°C (+130°C in stainless steel version)	
Permissible Ambient Temperature	-20...+80°C	
Temperature Deviation	approx. 1% per 20°C	
Adjustment Temperature	20°C	on request
Switching Contact	1 or 2 switching contacts (SPDT) - for details see switching contacts overview	
Switching Accuracy	≤ 1,0% FS	
Switching Differential (Hysteresis)	see switching contacts overview	
Repeatability	≤ 0,5% FS	
Analogue Output	4 - 20 mA (2-wire)	0 - 10 V (3-wire)
Supply for Analogue Output	12 - 32 VDC	
Accuracy of Analogue Output	< 0,5% FS	
Accuracy of integrated Gauge	Class 1.0 (available for pressure range -1...0 bar / 0 - 1 bar...0 - 250 bar)	
Process Connection	1/4" BSP male (EN837)	1/2" BSP male (EN837); others on request
Electrical Connection	2x plug	on request
Weight	approx. 1.5 kg (depending on switching function)	
Protection	IP65	
<b>Other Options</b>		
Scales in different units (e.g. MPa, kPa, psi, etc.); Dual Scale; Customer specific Scales		
silicone free version; version for O2 service		

## DIMENSIONS

### MANOCOMB-TM Standard Version

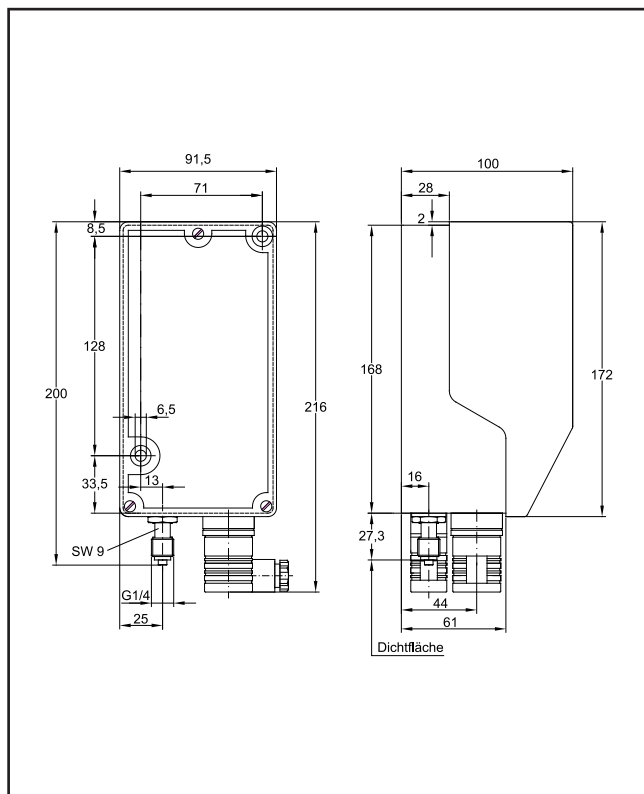

## SWITCHING CONTACTS

### Micro Switch

Type		24V	48V	110V	240V	SD <sup>1</sup>
Standard	A (AC)	5	5	5	5	≤ 1,0 %
	A (DC)	1	0,5	-	-	
MG <sup>2</sup>	A (AC)	1	1	1	-	≤ 1,5 %
	A (DC)	1	0,5	0,2	-	
MH	A (AC)	5	5	5	5	≤ 1,5 %
	A (DC)	1	0,5	-	-	
CS	A (AC)	5	5	5	5	≤ 2,0 %
	A (DC)	5	2	0,4	0,2	
CH	A (AC)	12	12	10	10	≤ 2,0 %
	A (DC)	10	2	0,4	0,2	
CZ <sup>3</sup>	A (AC)	5	5	5	5	≤ 2,0 %
	A (DC)	5	2	0,4	0,2	

<sup>1</sup> typical switching differential (hysteresis) from 1 - 250 bar; Deviation in % of FS

<sup>2</sup> micro switch with gold-plated contacts

<sup>3</sup> micro switch with forced circuit opening

## ELECTRICAL CONNECTION

shown in zero-pressure condition

### Plug ISO 4400<sup>2</sup> Micro Switch

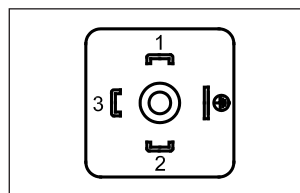

### Plug ISO 4400<sup>2</sup> Analogue Output

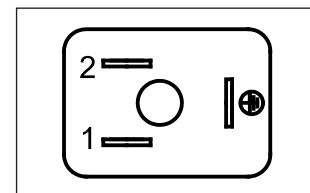

		plug ISO4400 (4-pin)	plug ISO4400 (3-pin)
Micro Switch	Normally Closed	1	
	Normal Open	2	
	Common	3	
Analogue Output	Supply +		1
	Supply -		2
	GND	GND	GND

<sup>1</sup> standard wiring - customer specific wiring on request

<sup>2</sup> on 2K versions 2x ISO 4400 plugs or 1x 7-pin plug

## PRESSURE LIMITER

External interlock

When used as a pressure limiter acc. to Vd-TÜV leaflet Pressure 100/1 the switch condition must be locked once the the pressure rises beyond the adjusted setpoint.

Before unlocking the interlock the reason for the pressure rise must be clarified and corrected. Please contact our sales team for recommended external interlock.

## PRESSURE LIMITER

Internal interlock

Pressure limiters with internal interlock feature an integrated interlock.

With a manual reset on the device the interlock is re-opened

An external interlock is not necessary.

For pressure limiters with internal interlock please see MANOCOMB-IP65/CV on page 16.

## ORDER CODES

(with most common options)

Order Codes		M	0	9	x	x	x	-	x	-	x	x	x
Switching Function	1K				0								
	1KA				1								
	2K				2								
	2KA				3								
Material	brass					1							
	stainless steel					2							
Switching Contact	Standard + 4 - 20 mA						1						
	MG + 4 - 20 mA						2						
	Standard + 0 - 10 V						8						
	MG + 0 - 10 V						9						
Pressure Ranges	-1...0 bar								006				
	0 - 1 bar								020				
	0 - 1,6 bar								022				
	0 - 2,5 bar								023				
	0 - 4 bar								024				
	0 - 6 bar								025				
	0 - 10 bar								026				
	0 - 16 bar								027				
	0 - 25 bar								028				
	0 - 40 bar								029				
	0 - 60 bar								030				
	0 - 100 bar								031				
	0 - 160 bar								032				
	0 - 250 bar								033				
0 - 400 bar								035					
Process Connection	G 1/4 B, brass											A	
	G 1/4 B, stainless steel											B	
	G 1/2 B, brass											C	
	G 1/2 B, stainless steel											D	
Electr. Connection	1x plug ISO 4400 (4-pin) + 1x Stecker ISO 4400 (3-pin) - only 1K - only 4 - 20 mA												P
	2x plug ISO 4400 (4-pin) - only 1K												Q
	1x plug 7-pin + 1x plug ISO 4400 (4-pin) - nur 2K												S
Further Options	no further options												O
	cleaned for O2 service												A
	cover lead-sealable												W

## MANOCOMB® Precision Pressure Switch Model IP54



- friction-free force-balance measuring system
- very high repeatability
- extraordinary long-term stability
- measuring ranges from -1... 0 bar up to 0 - 400 bar
- comfortable setpoint adjustment on calibrated scale
- **optionally integrated pressure gauge**
- **optionally with air gap contacts**

### Description

The MANOCOMB®-IP54 is a precision pressure switch for measuring pressure, differential pressure and vacuum of gaseous or liquid, also aggressive, crystallizing and highly viscous media.

### Operating Principal

The operation is based on force-balance - per change-over contact a metal bellows is available, which is opposed by a precision spring with an adjustable force.

Once the process pressure overcomes the set force the change-over is triggered.

The contact adjustment is done by removing the cover and turning the thumb wheel to the desired set point.

The set point adjustment can be comfortably read from the set point scale. No reference instrument is needed.

The measuring system, which actuates the switching contact works friction-free, resulting in minimal wear. No maintenance or spare parts are needed!

### Integrated Pressure Gauge

The optionally integrated pressure gauge (class 1.0) visualizes the actual process pressure right next to the set point indicator.

### Approvals

GOST

GOST-R Certification

Proof of Conformity with russian quality standards and regulations

Switching Function	Description
1K	1x change-over contact
1KA	1x change-over contact, 1x integrated gauge
2K	2x change-over contact
2KA	2x change-over contact, 1x integrated gauge
2KP	2x change-over contact, separate measuring systems
2K2AP	2x change-over contact, separate measuring systems with 1x integrated gauge each
1KPDi	1x change-over contact, differential pressure
1K2APDi	1x change-over contact, differential pressure, 2x integrated gauge - 1x for + und - inlet

Technical Data	Standard	Option
Function	mechanical pressure switch; force-balance measuring systems with bellows sensor	
Life Cycle	at least 10 Mio switch cycles	
Low Pressure Ranges	0 - 60 mbar; 0 - 100 mbar; 0 - 160 mbar; 0 - 250 mbar; 0 - 400 mbar; 0 - 600 mbar	
Pressure Ranges	0 - 1 bar; 0 - 1,6 bar; 0 - 2,5 bar; 0 - 4 bar; 0 - 6 bar; 0 - 10 bar; 0 - 16 bar; 0 - 25 bar; 0 - 40 bar; 0 - 60 bar	
High Pressure Ranges	0 - 100 bar; 0 - 160 bar; 0 - 250 bar; 0 - 400 bar	
Vacuum Ranges	-1...0 bar; -600...0 mbar; -400...0 mbar; -250...0 mbar; -160...0 mbar; -100...0 mbar; -60...0 mbar	
Over Pressure Safety	1,5x FS	
Vacuum Safety	-1 bar	
Housing Material	enhanced plastics with transparent cover	
Wetted Parts Material	brass	Stainless Steel 1.4571 (AISI 316Ti)
Permissible Media Temperature	-20...+80°C (+130°C in stainless steel version)	
Permissible Ambient Temperature	-20...+80°C	
Temperature Deviation	approx. 1% per 20°C	
Adjustment Temperature	20°C	on request
Switching Contact	1 or 2 switching contacts (SPDT) or 1 or 2 air gap contacts	
Contact Adjustment Accuracy	≤ 1,0% FS	
Switching Differential (Hysteresis)	see switching contacts overview	
Repeatability	≤ 0,5% FS	
Accuracy of integrated Gauge	Class 1.0 (available for pressure range -1...0 bar / 0 - 1 bar...0 - 250 bar)	
Process Connection	1/4" BSP male (EN837)	others on request
Weight	approx. 1.5 kg (depending on switching function)	
Protection	IP65	
<b>Version with Micro Switch</b>		
Electrical Connection	3m cable	ISO 4400 plug; Harting HAN7D/8U plug
<b>Version with Air Gap Contacts</b>		
Supply Air	1,4 bar	
Supply Media	< 40 µm filtered, not oiled compressed air	
Overpressure Safety Contact System	2,5 bar	
Consumption	≤ 75 NL/h	
max. Switch Frequency	35 Hz	
Pneumatic Connection	for hose pipe Ø 6	
<b>Other Options</b>		
Scales in different units (e.g. MPa, kPa, psi, etc.); Dual Scale; Customer specific Scales		
silicone free version; version for O2 service		

## DIMENSIONS

### MANOCOMB-IP54 Standard Version

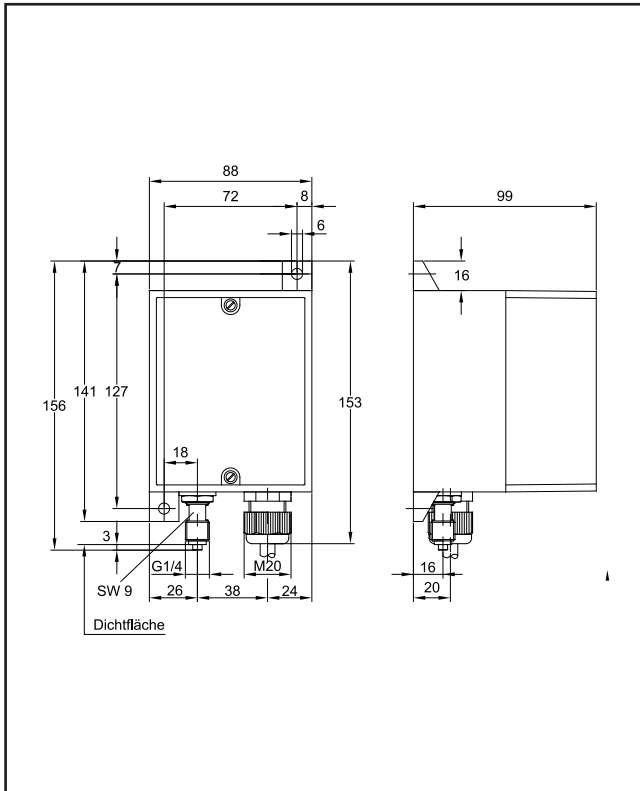

### MANOCOMB-IP54/L Standard Version with Air Gap Contact(s)

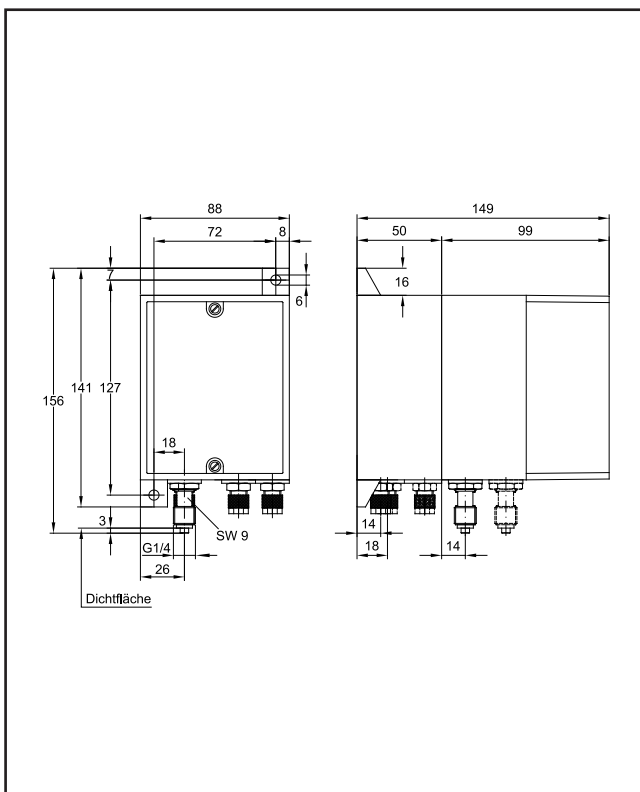

## SWITCHING CONTACTS

### Micro Switches

Type		24V	48V	110V	240V	SD <sup>1</sup>
Standard	A (AC)	5	5	5	5	≤ 1,0 %
	A (DC)	1	0,5	-	-	
MG <sup>2</sup>	A (AC)	1	1	1	-	≤ 1,5 %
	A (DC)	1	0,5	0,2	-	
MH	A (AC)	5	5	5	5	≤ 1,5 %
	A (DC)	1	0,5	-	-	
CS	A (AC)	5	5	5	5	≤ 2,0 %
	A (DC)	5	2	0,4	0,2	
CH	A (AC)	12	12	10	10	≤ 2,0 %
	A (DC)	10	2	0,4	0,2	

### Air Gap Contact

Type	SD <sup>1</sup>
L	≤ 1,0 %

<sup>1</sup> typical switching differential (hysteresis) from 1 - 250 bar; Deviation in % of FS  
<sup>2</sup> micro switch with gold-plated contacts

## ELECTRICAL CONNECTION<sup>1</sup>

shown in zero pressure condition

### Cable

Pressure, Differential P.

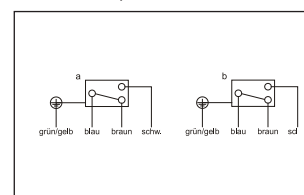

### Cable

Vacuum

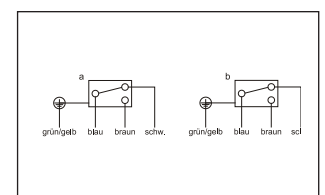

<sup>1</sup> standard wiring - customer specific wiring on request

## PNEUMATIC CONNECTION

shown in zero pressure condition

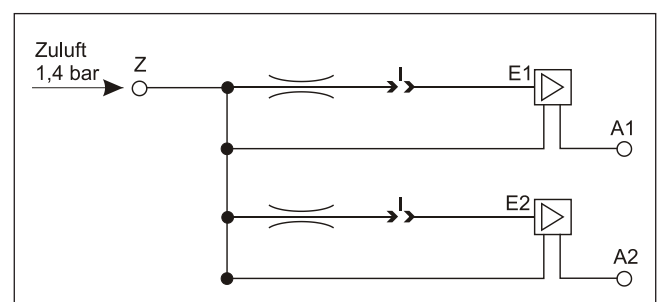

## ORDER CODES

(with most common options)

Order Code		M	0	3	x	x	x	-	x	(x)	-	x	x	x
Switching Function	1K				0									
	1KA				1									
	2K				2									
	2KA				3									
	2KP				4									
	2K2AP				5									
	1KPDi				7									
	1K2APDi				8									
Material	brass								1					
	Stainless Steel 1.4571 (AISI 316Ti)								2					
Switching Contact	Standard												A	
	MG												B	
	MH												C	
	CS												H	
	CH												G	
	L (Luftschneidekontakt)												L	
Pressure Range	-1...0 bar													006
	-60...0 mbar													000
	0 - 60 mbar													010
	0 - 100 mbar													011
	0 - 160 mbar													012
	0 - 250 mbar													013
	0 - 400 mbar													014
	0 - 600 mbar													015
	0 - 1 bar													020
	0 - 1,6 bar													022
	0 - 2,5 bar													023
	0 - 4 bar													024
	0 - 6 bar													025
	0 - 10 bar													026
	0 - 16 bar													027
	0 - 25 bar													028
	0 - 40 bar													029
	0 - 60 bar													030
	0 - 100 bar													031
	0 - 160 bar													032
0 - 250 bar													033	
0 - 400 bar													035	
2nd Pressure Range	differential pressure range or 2. pressure range on switching function 2K(2A)P codes as above; leave empty on other models													
Process Connection	G 1/4 B, brass													A
	G 1/4 B, Stainless Steel 1.4571 (AISI 316Ti)													B
	G 1/2 B, brass													C
	G 1/2 B, Stainless Steel 1.4571 (AISI 316Ti)													D
Electr. Connection	3m cable													K
	plug ISO 4400													B
	plug Harting HAN7D													X
	plug Harting HAN8U													Z
Pneum. Connection	for hose / pipe Ø6													5
Weitere Optionen	no further options													O
	cleaned for O2 service													A
	cover lead-sealable													W
	47 kOhm resistor													AL

## MANOCOMB® Precision Pressure Switch Model 96x96



- friction-free force-balance measuring system
- very high repeatability
- extraordinary long-term stability
- measuring ranges from -1... 0 bar up to 0 - 400 bar
- comfortable setpoint adjustment on calibrated scale
- **optionally integrated pressure gauge**
- **for rack mount**

### Description

The MANOCOMB®-IP65 is a precision pressure switch for measuring pressure, differential pressure and vacuum of gaseous or liquid, also aggressive, crystallizing and highly viscous media.

### Operating Principal

The operation is based on force-balance - per change-over contact a metal bellows is available, which is opposed by a precision spring with an adjustable force.

Once the process pressure overcomes the set force the change-over is triggered.

The contact adjustment is done by removing the cover and turning the thumb wheel to the desired set point.

The set point adjustment can be comfortably read from the set point scale. No reference instrument is needed.

The measuring system, which actuates the switching contact works friction-free, resulting in minimal wear. No maintenance or spare parts are needed!

### Integrated Pressure Gauge

The optionally integrated pressure gauge (class 1.0) visualizes the actual process pressure right next to the set point indicator.

### Zulassungen

GOST

GOST-R Zertifizierung

Nachweis der Konformität mit russ. Qualitätsstandards und Bestimmungen



Switching Function	Description
1K	1x change-over contact
1KA	1x change-over contact, 1x integrated gauge
2K	2x change-over contact
2KA	2x change-over contact, 1x integrated gauge
2KP	2x change-over contact, separate measuring systems
2K2AP	2x change-over contact, separate measuring systems with 1x integrated gauge each
1KPDi	1x change-over contact, differential pressure
1K2APDi	1x change-over contact, differential pressure, 2x integrated gauge - 1x for + und - inlet

Technical Data	Standard	Option
Function	mechanical pressure switch; force-balance measuring systems with bellows sensor	
Life Cycle	at least 10 Mio switch cycles	
Low Pressure Ranges	0 - 60 mbar; 0 - 100 mbar; 0 - 160 mbar; 0 - 250 mbar; 0 - 400 mbar; 0 - 600 mbar	
Pressure Ranges	0 - 1 bar; 0 - 1,6 bar; 0 - 2,5 bar; 0 - 4 bar; 0 - 6 bar; 0 - 10 bar; 0 - 16 bar; 0 - 25 bar; 0 - 40 bar; 0 - 60 bar	
High Pressure Ranges	0 - 100 bar; 0 - 160 bar; 0 - 250 bar; 0 - 400 bar	
Differential Pressure	see pressure ranges; max ratio between static and differential pressure 10:1; others on request	
Vacuum Ranges	-1...0 bar; -600...0 mbar; -400...0 mbar; -250...0 mbar; -160...0 mbar; -100...0 mbar; -60...0 mbar	
Over Pressure Safety	1,5x FS	
Vacuum Safety	-1 bar	
Housing Material	sheet steel black, window plastic	
Wetted Parts Material	brass	Stainless Steel 1.4571 (AISI 316Ti)
Permissible Media Temperature	-20...+80°C (+130°C in stainless steel version)	
Permissible Ambient Temperature	-20...+80°C	
Temperature Deviation	approx. 1% per 20°C	
Adjustment Temperature	20°C	on request
Switching Contact	1 or 2 switching contacts (SPDT) - for details see switching contacts overview	
Contact Adjustment Accuracy	≤ 1,0% FS	
Switching Differential (Hysteresis)	see switching contacts overview	
Repeatability	≤ 0,5% FS	
Accuracy of integrated Gauge	Class 1.0 (available for pressure range -1...0 bar / 0 - 1 bar...0 - 250 bar)	
Process Connection	1/4" BSP male (EN837)	on request
Weight	approx. 1.5 kg (depending on switching function)	
Protection	IP20	IP65 front facing (with optional lockable window)
Electrical Connection	terminal blocks	
<b>Other Options</b>		
Scales in different units (e.g. MPa, kPa, psi, etc.); Dual Scale; Customer specific Scales		
silicone free version; version for O2 service		

## DIMENSIONS

### MANOCOMB-96x96 Standard Version

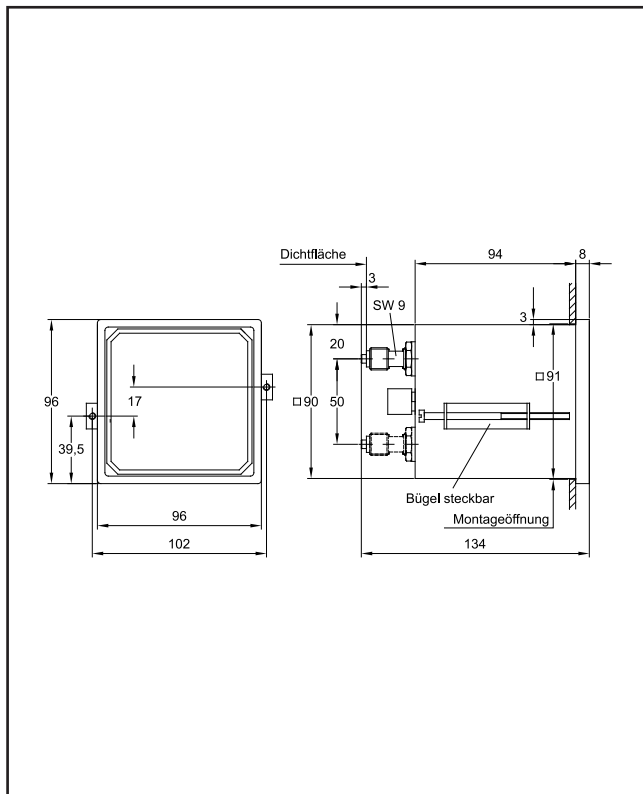

### MANOCOMB-96x96 Standard Version 2K(2A)P and 1K(2A)PDi

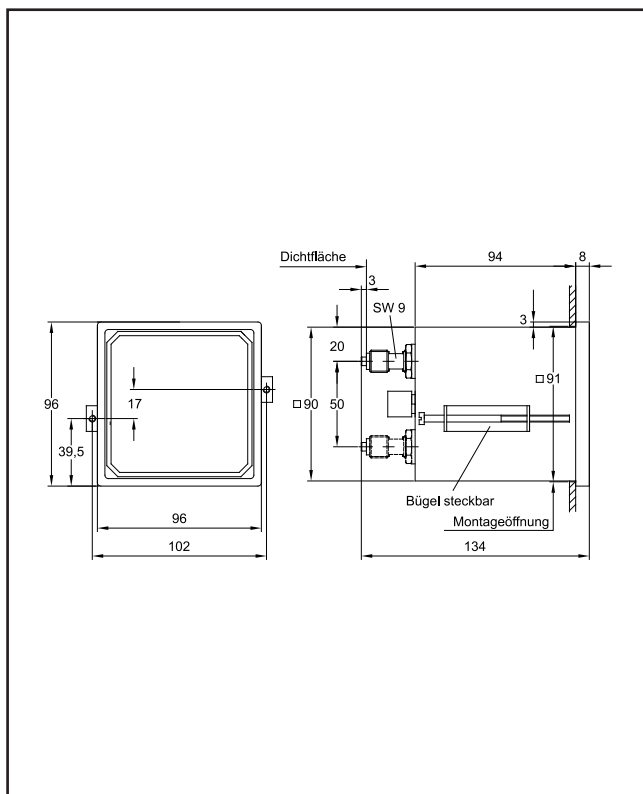

## SWITCHING CONTACTS

### Micro Switches

Type		24V	48V	110V	240V	SD <sup>1</sup>
Standard	A (AC)	5	5	5	5	≤ 1,0 %
	A (DC)	1	0,5	-	-	
MG <sup>2</sup>	A (AC)	1	1	1	-	≤ 1,5 %
	A (DC)	1	0,5	0,2	-	
MH	A (AC)	5	5	5	5	≤ 1,5 %
	A (DC)	1	0,5	-	-	
CS	A (AC)	5	5	5	5	≤ 2,0 %
	A (DC)	5	2	0,4	0,2	
CH	A (AC)	12	12	10	10	≤ 2,0 %
	A (DC)	10	2	0,4	0,2	

### Inductive Contacts

Type	Function	Output polarity	SD <sup>1</sup>
I-N	NAMUR NC	NAMUR	≤ 1,0 %
I-SN	NAMUR NC	safety function	≤ 1,0 %
I-S1N	NAMUR NO	safety function	≤ 1,0 %

<sup>1</sup> typical switching differential (hysteresis) from 1 - 250 bar; Deviation in % of FS

<sup>2</sup> micro switch with gold-plated contacts

## ELECTRICAL CONNECTION<sup>1</sup>

shown in zero pressure condition

### Terminal Blocks Pressure, Differential P.

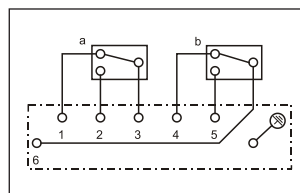

### Terminal Blocks Vacuum

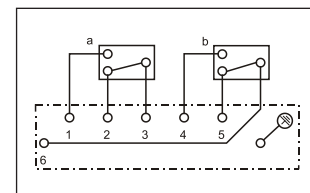

<sup>1</sup> standard wiring - customer specific wiring on request

## ORDER CODES

(with most common options)

Order Code		M	0	5	x	x	x	-	x	(x)	-	x	I	x
Switching Function	1K				0									
	1KA				1									
	2K				2									
	2KA				3									
	2KP				4									
	2K2AP				5									
	1KPDi				7									
	1K2APDi				8									
Material	brass													1
	Stainless Steel 1.4571 (AISI 316Ti)													2
Switching Contact	Standard													A
	MG													B
	MH													C
	CS													H
	CH													G
	I-N													J
	I-SN													K
	I-S1N													W
Switching Contact	-1...0 bar													006
	-60...0 mbar													000
	0 - 60 mbar													010
	0 - 100 mbar													011
	0 - 160 mbar													012
	0 - 250 mbar													013
	0 - 400 mbar													014
	0 - 600 mbar													015
	0 - 1 bar													020
	0 - 1,6 bar													022
	0 - 2,5 bar													023
	0 - 4 bar													024
	0 - 6 bar													025
	0 - 10 bar													026
	0 - 16 bar													027
	0 - 25 bar													028
	0 - 40 bar													029
	0 - 60 bar													030
	0 - 100 bar													031
	0 - 160 bar													032
0 - 250 bar													033	
0 - 400 bar													035	
2nd Pressure Range	differential pressure range or 2. pressure range on switching function 2K(2A)P codes as above; leave empty on other models													
Prozessanschluss	G 1/4 B, brass													A
	G 1/4 B, Stainless Steel 1.4571 (AISI 316Ti)													B
	G 1/2 B, brass													C
	G 1/2 B, Stainless Steel 1.4571 (AISI 316Ti)													D
Further Options	no further options													O
	cleaned for O2 service													A
	window lockable (IP65)													W

**PINTER • PRODUCTS • PRACTISE**
**MANOCOMB-TM special version**  
 with overpressure safety valve

**MANOCOMB-IP65**  
 with Harting plug H8U + chemical seal CHEMSEAL® Type FT

**MANOCOMB-IP65**  
 Pressure Monitor and Safety Pressure Limiter (with manual reset)

**MANOCOMB-IP65**  
 chemical seal CHEMSEAL® Type MT

## MANOCOMB with pneumatic switch contacts

special design for 3-way redundant monitoring

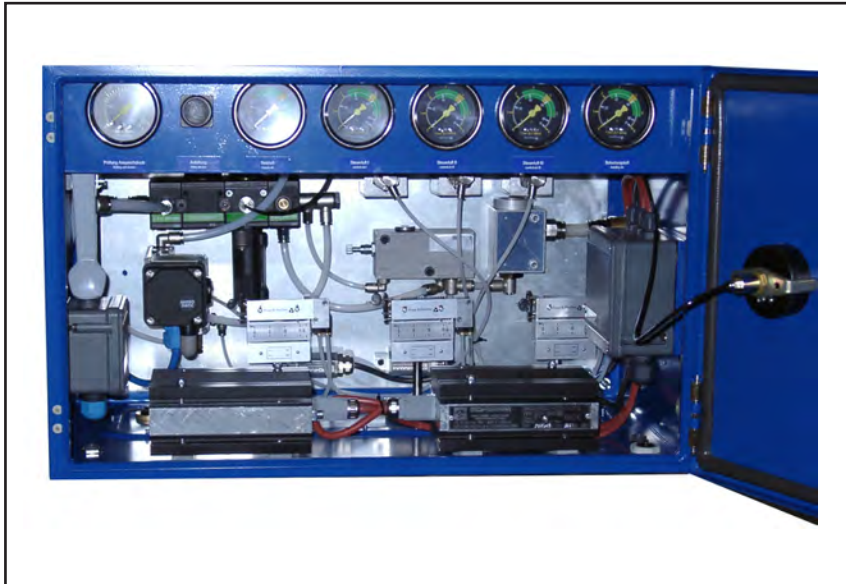

Special version of the MANOCOMB® pressure switch as the maximum pressure limiter with pneumatic switch contacts for safety valve control devices.

These control devices are used to control spring-loaded safety valves with a pneumatic drive for loading and lifting air.

The controller operates according to the principle of quiescent with the external medium air. The associated safety valves operate on the principle of relief.

Safety valves are used to protect the system against excessive pressure by a very large discharge capacity and controlled opening in the sliding operation; in power plant operation as well as for processes in the chemical and petrochemical industry.

For more information about this design, please contact our sales team.

## MANOCOMB-IP65/PN

MIN and MAX monitoring of the process pressure



MANOCOMB® pressure switches in pneumatic version for monitoring of MIN and MAX switching points in pneumatic „safety device for natural gas production“

The MIN and MAX switching points are adjustable from 0 to 160 bar and monitor the stable supply of the gas pipeline. The built-in pressure gauge shows the current process pressure.

For additional security, a second MANOCOMB® pressure switch both indicates and monitors the control air supply.

Read more about this version and the safety equipment in our ENGINEERING REPORT „safety device for natural gas production“ or contact our sales team.

**CONVERSION TABLE FOR PRESSURE UNITS**

		Standard International Units					Technical Units					
		mbar	bar	Pa	kPa	MPa	mm WC	m WC	kp/cm <sup>2</sup>	atm	Torr	psi
Standard International Units	mbar	•	0,001	100	0,1	0,0001	10,197	10,197 x 10 <sup>-3</sup>	1,0197 x 10 <sup>-3</sup>	0,98692 x 10 <sup>-3</sup>	0,75006	14,504 x 10 <sup>-3</sup>
	bar	1.000	•	100.000	100	0,1	10,197 x 10 <sup>3</sup>	10,197	1,0197	0,9869	750,06	14,504
	Pa	0,01	0,00001	•	0,001	0,000001	0,10197	0,10197 x 10 <sup>-3</sup>	0,10197 x 10 <sup>-6</sup>	9,8692 x 10 <sup>-6</sup>	7,5006 x 10 <sup>-3</sup>	0,14504 x 10 <sup>-3</sup>
	kPa	10	0,01	1.000	•	0,001	0,10197 x 10 <sup>3</sup>	0,10197	10,197 x 10 <sup>-3</sup>	9,8692 x 10 <sup>-3</sup>	7,5006	0,14504
	MPa	10.000	10	1.000.000	1.000	•	0,10197 x 10 <sup>6</sup>	0,10197 x 10 <sup>3</sup>	10,197	9,8692	7,5006 x 10 <sup>3</sup>	0,14504 x 10 <sup>3</sup>
Technical Units	mm WS	98,067 x 10 <sup>-3</sup>	98,067 x 10 <sup>-6</sup>	9,8067	9,8067 x 10 <sup>-3</sup>	9,8067 x 10 <sup>-6</sup>	•	10 <sup>-3</sup>	10 <sup>-1</sup>	96,784 x 10 <sup>-6</sup>	73,556 x 10 <sup>-3</sup>	1,4223 x 10 <sup>-3</sup>
	m WS	98,067	98,067 x 10 <sup>3</sup>	9,8067 x 10 <sup>3</sup>	9,8067	9,8067 x 10 <sup>-3</sup>	10 <sup>3</sup>	•	10 <sup>-1</sup>	96,784 x 10 <sup>-3</sup>	73,556	1,4223
	kp/cm <sup>2</sup>	0,98067 x 10 <sup>3</sup>	0,98067	98,067 x 10 <sup>3</sup>	98,067	98,067 x 10 <sup>-3</sup>	10 <sup>4</sup>	10	•	0,96784	735,56	14,223
	atm	1,0133 x 10 <sup>3</sup>	1,0133	0,10133 x 10 <sup>5</sup>	0,10133 x 10 <sup>5</sup>	0,10133	10,332 x 10 <sup>3</sup>	10,332	1,0332	•	760	14,693
	Torr	1,3332	1,3332 x 10 <sup>3</sup>	0,10133 x 10 <sup>3</sup>	0,10133	0,13332 x 10 <sup>-3</sup>	13,595	13,595 x 10 <sup>3</sup>	1,3595 x 10 <sup>3</sup>	1,3158 x 10 <sup>-3</sup>	•	19,34 x 10 <sup>-3</sup>
	psi	68,948	68,948 x 10 <sup>3</sup>	6,8948 x 10 <sup>7</sup>	6,8948	6,8948 x 10 <sup>-3</sup>	0,70307 x 10 <sup>3</sup>	0,70307	0,70307 x 10 <sup>3</sup>	0,70307 x 10 <sup>-6</sup>	51,715	•

## INQUIRY CHECKLIST PRESSURE SWITCHES (BY FAX TO +49-6262-92670-99)

Company's name and address	contact person
	telephone, fax
inquiry no. / project no.	E-Mail
application	measured media
wetted parts material	housing material
media temperature $T_{min}$ $T_{max}$	environmental temperatur $T_{min}$ $T_{max}$
pressure load static:                                      dynamic: from                      to	vacuum <input type="checkbox"/> Yes <input type="checkbox"/> No
special requirements	

### Design pressure switch

model	explosion proof version <input type="checkbox"/> No <input type="checkbox"/> EExi <input type="checkbox"/> EExd <input type="checkbox"/> _____
number of switching contacts <input type="checkbox"/> 1 <input type="checkbox"/> 2 <input type="checkbox"/> _____	set point(s) - falling /rising?
switching contact type <input type="checkbox"/> micro switch <input type="checkbox"/> inductive <input type="checkbox"/> pneumatic	switching performance (mech. and electr. for micro switch)
actual value indicator (integrated pressure gauge) <input type="checkbox"/> Yes <input type="checkbox"/> No	analogue signal (integrated pressure transducer 4 - 20mA) <input type="checkbox"/> Yes <input type="checkbox"/> No
pressure range	differential pressure range
process connection <input type="checkbox"/> BSP <input type="checkbox"/> NPT <input type="checkbox"/> chemical seal <small>see checkliste chemical seal</small> <input type="checkbox"/> others <input type="checkbox"/> 1/4 <input type="checkbox"/> 1/2 <input type="checkbox"/> male <input type="checkbox"/> female	
electrical connection <input type="checkbox"/> M20/terminal blocks <input type="checkbox"/> wired cable _____ meter <input type="checkbox"/> others <input type="checkbox"/> plug ISO4400 <input type="checkbox"/> Harting plug	
approvals / certificates	
other	
Quotation for pieces _____	<input type="checkbox"/> annual demand <input type="checkbox"/> single demand <input type="checkbox"/> project demand <input type="checkbox"/> spare parts

**PINTER Mess- und Regeltechnik GmbH**  
**Kraichgaublick 17**  
**Technologiepark Neckartal-Odenwald**  
**74847 Obrigheim, Germany**

**Phone** +49-6262-92670-0  
**Fax** +49-6262-92670-99  
**E-Mail** [info@pinter-gmbh.de](mailto:info@pinter-gmbh.de)  
**Internet** [www.pinter-gmbh.com](http://www.pinter-gmbh.com)

All given information and/or technical data in this document have been prepared very carefully and reflect the state of the art when printed. Information and/or technical data may change without prior notice.

All given information and/or technical data in this document are not binding and for information purposes only. Binding information and/or technical data can be obtained from our quotations and/or order confirmations. Please understand that we cannot be held responsible for the correctness of any given information and/or technical data in this document.

When installing or maintaining PINTER products always refer to the corresponding operating manual and technical data sheet.

All mentioned product names, product designations, product descriptions and logos are trademarks and property of their respective owners. CHEMSEAL, DIMIO, INDUSENS, INDUSWITCH, INTELLICOMB, MANOCOMB, MINICOMB are trademarks and/or registered trademarks of the PINTER Mess- und Regeltechnik GmbH and/or their affiliated companies in Germany, the European Union, Switzerland and/or other countries. The use of PINTER trademarks is prohibited if not clearly agreed otherwise.